



MVR / MVR Pro

Medical Video Recorder

Instructions for Use

English

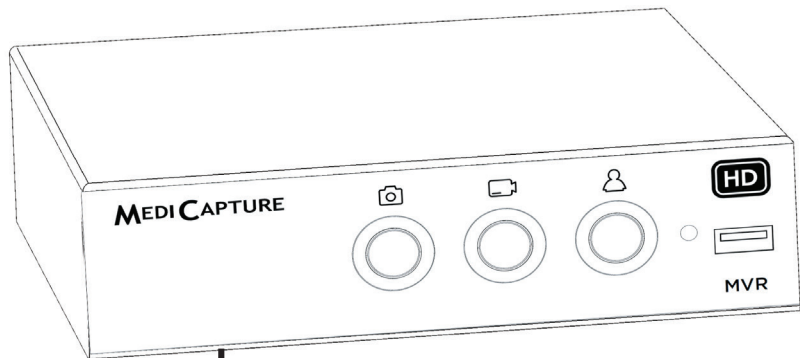
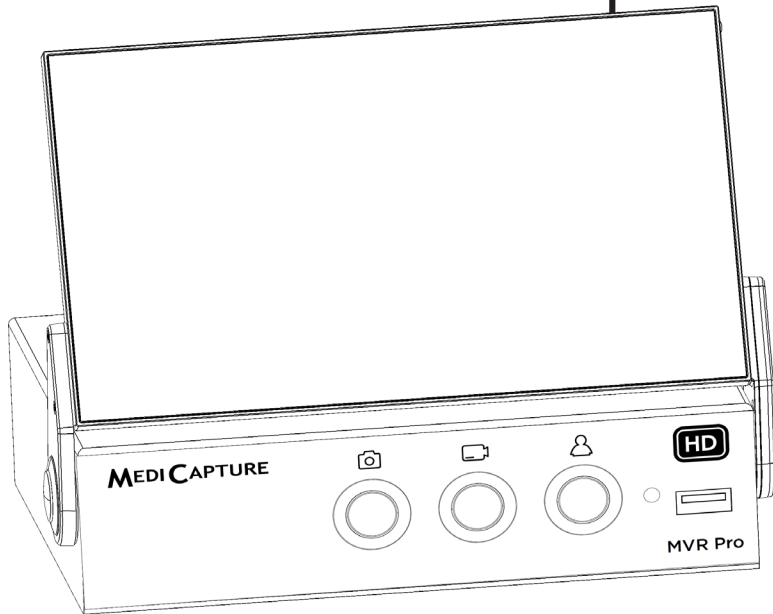

Applies to Firmware 180810 and higher.







medicapture.com/support

















For more translations (available in pdf), please visit www.medicapture.com/support

MVR/MVRPRO-IFU01-EN-220101-MC

Precautions for Use

Symbols in the manual			
	<p>Warning Indicates a potentially hazardous situation or improper use that could result in serious personal injuries or death.</p> <p>NOTE: Background color: Yellow Triangular band: Black Symbol: Black</p>	 Medical Device	
	<p>Caution Indicates a potentially hazardous situation or improper use which, if not avoided, may result in minor or moderate injury and/or appreciable material, financial and environmental damage.</p>	<p><small>medicaputure.com/support</small></p>  This symbol informs the user that these Instruction for Use and translated copies can be downloaded from the MediCapture website at: www.medicapture.com/support	
	This image indicates the manufacturer and appears next to the manufacturer's name and address.		This symbol indicates the equipotential pole which brings the various parts of a system to the same potential.

Symbols on the product (Not all symbols are printed in all regions)			
	Before attempting to set up the product, carefully read through the Instructions for Use.		This symbol indicates the equipotential pole which brings the various parts of a system to the same potential.
	This symbol indicates the manufacturer and appears next to the manufacturer's name and address.		This symbol indicates compliance with the Waste Electrical and Electronic Equipment Directive (WEEE Directive). The product contains waste from electrical and electronic equipment, and should be separately collected and not disposed of as unsorted municipal waste.
	This symbol indicates date of manufacturing. It can also show the country of origin.		Description of device (Catalog number)
	Medical Device		Serial Number
	Conformité Européenne (European Conformity)		Unique Device Identifier
	Underwriters Laboratories (UL®) mark		This symbol indicates MediCapture's European Representative.
	Federal Communications Commission - Declaration of Conformity		I : AC power ON O : AC power OFF

**WARNING**

To avoid risk of electric shock, this equipment must only be connected to a supply mains with protective earth.

Do not modify this equipment without authorization of the manufacturer.

To avoid risk of electric shock, replace the fuse only by qualified service personnel, and only with the type specified in the Instructions for Use.

To reduce the risk of fire or shock hazard, do not expose this equipment to rain or moisture, this device is designed for indoor use only.

Do not connect / disconnect physical video connections when power is on. This device may get hot during operation, especially at the bottom and rear. When changing physical video connections, wait until device has cooled down before reconnecting device.

External equipment, intended for connection to signal input / output or other connectors, shall comply with UL/EN 60601-1 for medical electrical equipment. Anyone who connects equipment to the signal input part or signal output part is configuring a medical system, and is therefore, responsible that the system complies with the requirements of medical system standard IEC 60601-1-1.

Equipment not complying with UL/EN/IEC 60601-1 shall be kept outside the patient environment, as defined on the systems standard.

Note:

To the user and/or patient: Any serious incident related to the product shall be reported to the manufacturer and to the competent authority of the Member State where the user/patient is established.

**CAUTION**

To reduce the risk of fire or shock hazard and annoying interference, use the recommended accessories only.

Do not use the images for diagnosis or evaluation purposes. The compression reduces the information of the picture and is therefore not appropriate for diagnosis.

It is important to observe your obligations as the operator of this medical device to ensure its safe operation with no risk of danger to patients, users or third parties. If no other local law is applicable, it is recommended that a safety and document test be performed at least once every 2 years according to EN 62353. It is important to ensure that persons performing the safety check have the necessary qualifications.







The antenna-to-user (bystander) separation distance must be greater than 20 cm.

After a strong electrical disturbance, like lightning or a strong electrostatic discharge, the output signal may shake, change in color, or turn black. If you see these symptoms, restart the device by turning off the power, waiting a few seconds, and then turning on the power.













Disposal Method: Use your local regulations for proper disposal.

Précautions d'utilisation

Symboles utilisés dans le manuel

	AVERTISSEMENT Indique une situation potentiellement dangereuse ou une utilisation incorrecte pouvant causer des blessures graves ou la mort. NOTE : Couleur de fond : jaune Contour du triangle : noir Symbole : noir		Dispositif médical (Medical Device)
	ATTENTION Indique une situation potentiellement dangereuse ou une utilisation incorrecte pouvant, si elle n'est pas évitée, occasionner des blessures légères à modérées et/ou d'importants dommages matériels, financiers et environnementaux.		Ce symbole informe l'utilisateur que ce mode d'emploi et des copies traduites peuvent être téléchargés sur le site Web de MediCapture à l'adresse suivante www.medicapture.com/support
	Cette image désigne le fabricant ; elle apparaît à côté du nom et de l'adresse du fabricant.		Ce symbole indique le pôle d'équipotentialité qui met les différents éléments d'un système au même potentiel.

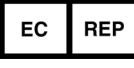
Symboles utilisés sur le produit (Tous les symboles ne sont pas imprimés dans toutes les régions.)

	Avant d'installer le produit, lire attentivement le mode d'emploi.		Ce symbole indique le pôle d'équipotentialité qui met les différents éléments d'un système au même potentiel.
	Cette image désigne le fabricant ; elle apparaît à côté du nom et de l'adresse du fabricant.		Cette icône représente la conformité avec la directive sur les déchets d'équipements électriques et électroniques (directive WEEE). Le produit contient des déchets d'équipements électriques et électroniques, et doit être collecté séparément et non éliminé comme un déchet municipal non trié.
	Cette icône représente la date de fabrication. Il peut également indiquer le pays d'origine.		Description de l'appareil (numéro de catalogue)
	Dispositif médical		Numéro de série
	Conformité Européenne		Identificateur unique du dispositif. (Unique Device Identifier)
	Marque Underwriters Laboratories (UL®)		Ce symbole indique le représentant européen de MediCapture.
	Déclaration de conformité de la Federal Communications Commission		I : connexion à l'alimentation CA O : pas de connexion à l'alimentation CA

**MISE EN GARDE**

Pour éviter les risques de choc électrique, cet équipement ne doit être connecté qu'à une prise électrique avec borne de terre.

Ne pas modifier cet équipement sans autorisation expresse du fabricant.

Pour éviter les risques de choc électrique, le fusible ne peut être remplacé que par un personnel qualifié et seulement avec le modèle spécifié dans le manuel utilisateur.

Afin de réduire les risques d'incendie ou d'électrocution, n'exposez pas cet équipement à la pluie ou à l'humidité. Cet équipement est exclusivement destiné à un usage intérieur.

Ne pas connecter/déconnecter les connexions vidéo physiques lorsque l'appareil est sous tension ; l'appareil peut chauffer pendant le fonctionnement, en particulier en bas et à l'arrière, lorsque vous devez changer les connexions vidéo physiques, attendez que l'appareil ait refroidi avant de le reconnecter.

Avis :

A l'attention de l'utilisateur et/ou du patient : Tout incident grave lié au produit doit être signalé au fabricant et à l'autorité compétente de l'État membre où l'utilisateur/patient est établi.

**ATTENTION**

Afin de réduire les risques d'incendie ou de choc électrique et les interférences nuisibles, utilisez uniquement les accessoires recommandés.

Ne pas utiliser les images à des fins d'évaluation ou de diagnostic. La compression réduit l'information de l'image qui n'est en conséquence pas appropriée aux diagnostic.

L'exploitant doit utiliser cet équipement conformément aux recommandations du manuel utilisateur afin d'assurer un fonctionnement sans risque ni danger pour le patient, l'utilisateur ou tout autre partie. Si aucun règlement d'usage n'est disponible, il est recommandé de mettre en place et procéder à un test de sécurité conformément à la norme EN 62353 tous les 2 ans . Il est important que les personnes réalisant ces tests de sécurité aient les qualifications nécessaires.

La distance de séparation entre l'antenne et l'utilisateur (spectateur) doit être supérieure à 20 cm.

Après une perturbation électrique forte, comme la foudre ou une forte décharge électrostatique, le signal vidéo de sortie peut vaciller, changer de couleur ou devenir noir. Si ces symptômes apparaissent, redémarrer l'équipement en l'éteignant puis en le redémarrant après avoir attendu quelques secondes.

Mise au rebut : Pour la mise au rebut du produit, respecter les règlements et les lois appropriés valides dans votre pays.

Table of Contents

Ordering Information.....	6	Recording to Internal Storage.....	19
Technical Support.....	6	Recording to Network Storage	20
Residual Risks.....	7	Reviewing Studies on MVR / MVR Pro	20
Important Safety Instructions to avoid residual risks...	7	Archive.....	20
Data Protection.....	8	Deleting Data.....	21
Intended Use:	8	Reviewing Videos on MVR / MVR Pro	22
General Functional Description:	8	Reviewing Still images on MVR / MVR Pro	22
First installation / General preparations for safe		Creating and Printing Reports	23
operation and performance:.....	9	Report Header Image.....	23
Checks before you operate the device:	10	Viewing Still Images on Your Computer	23
Compatibility to Other Devices	10	Viewing Videos on Your Computer	23
Touchscreen Monitor	10	Other Features	23
MVR Pro only	10	Capturing Images While Recording Videos.....	23
Front Panel.....	11	Creating Tags in Video Files.....	23
Back Panel MVR / MVR Pro.....	11	Information Page / System Settings	24
Monitor User Interface	12	Device Info: Device ID / LAN MAC address / QR code ...	24
USB keyboard with integrated trackpad	12	MediCapture Automatic Video Repair Function	24
Remote Control	13	Footswitches and Camera Triggers	24
Remote control with a Remote Device (tablet) by		Settings (for Administrators)	25
using the MVR Remote App	13	Structure of Settings:.....	25
Connecting the MVR / MVR Pro.....	14	Locking / Protecting Advanced Settings	26
Inserting a USB Flash Drive	14	User Accounts for Security Protection	26
Creating Patient Data	15	Special Video Input Settings.....	28
Workflow after MVR / MVR Pro was switched on:	15	Picture-in-Picture Recording (PIP)	28
Using Patient Button to End Recording Study.....	15	Parallel Recording.....	28
Manual Patient Data Input.....	16	Recording Options	28
Search Recent Patient on Storage.....	16	Video Time Limit.....	28
Capturing Images	16	Time Lapse recording.....	28
Recording Videos	17	Pause Function	28
Pausing a Video Recording	17	Upgrades / Activation keys	29
Changing Input Signals in Live View = Multi Input.....	18	4K Recording Upgrade.....	29
Storage Options = Multi-Storage	18	Appendix A: MVR / MVR Pro Specifications.....	30
Recording to a USB Flash Drive.....	18	Compliance / Certification / Classification	31
Recording to a USB Hard Drive.....	19	FCC compliance information	32
Hard Drive Formats.....	19	European Union Radio Equipment Directive	
How to Determine the Format of a USB Hard Drive:	19	2014/53/EU.....	32
Transferring Images from a USB Drive to		Industry Canada Notice	33
Your Computer	19	Appendix B: MediCapture Limited Warranty.....	34

Ordering Information

MediCapture recommends MediCapture® Brand USB flash drives.
Please visit medicapture.com for information on how to purchase flash drives.

Technical Support

For technical support and other questions, please visit medicapture.com or
call 888-922-7887 (toll free from within the USA) or 001-503-445-6935 (from outside the USA).



MediCapture® Inc.
2250 Hickory Road, Suite 200
Plymouth Meeting, PA 19462
USA

EC REP: MediCapture Europe B.V.
Kraanpoort 10
6041 EG Roermond
Netherlands

Residual Risks

Important Safety Instructions to avoid residual risks.

1. Read all of these instructions.
2. Keep these instructions.
3. Heed all warnings in these instructions.
4. Follow all of these instructions.
5. Do not misuse this apparatus.
6. Make sure that your video source is directly connected to the monitor via primary safety wiring.
7. Clean the device regularly with a soft cloth moistened with surface disinfectant, alcohol or spirits. Follow the disinfectant manufacturer's instructions!
IMPORTANT! Make sure that no humidity enters the device. Do not use any cleaning agents, scouring agents or solvents on this device.
8. Do not block any of the ventilation openings. Install in accordance with the manufacturer's instructions.
9. Do not install near any heat source such as radiators, heat registers, stoves or other apparatus that produces heat.
10. Do not tamper with the polarized or grounding-type plug. A polarized plug has two types of blades with one being wider than the other. A grounding-type plug has two blades and a third grounding prong. The wide blade or third prong is provided for your safety. When the provided plug does not fit into your outlet, consult an electrician for replacement of the obsolete outlet.
11. Protect the power cord from being walked on or pinched especially near plugs, outlets, and the point where the cord exits from the apparatus.
12. Only use attachments/accessories specified by the manufacturer.
Use only hospital grade or equivalent power cord providing reliable grounding.
13. Use only with a cart, stand, tripod, bracket or table specified by the manufacturer, or sold with the apparatus. When a cart is used, use caution when moving the cart/apparatus combination to prevent the cart from tipping over and to avoid injury.
Place device in the position for easy disconnection of power cord.
14. Unplug this apparatus during lightning storms or when unused for long periods of time.
15. Disconnection Method: Switch off AC power by the rocker switch on the rear panel, disconnect power cord.
16. Do not place vessels containing water or other liquids (such as vases, etc.) on top of the apparatus. Do not splash water on top of the apparatus.
17. Refer all servicing to qualified service personnel. Servicing is required when the apparatus has been damaged in any way, such as when a power supply cord or plug has been damaged, liquid has been spilled on the apparatus, objects have fallen into the apparatus, and the apparatus has been exposed to rain or moisture, or does not operate normally, or has been dropped.
18. Service Equipment by qualified personnel only, where qualified personnel refers to the person with proper education or training assigned by the hospital, medical institution or authorized distributor.

Data Protection

Sensitive personal data is processed when using the devices of MediCapture. The user of a device of MediCapture is obligated, if the device is sent to MediCapture (i) for maintenance purposes (ii) under warranty (iii) after its use as a demo/ test device or (iv) for any other reason, to reset the device to its delivery state and to delete all personal data on the device.

The formatting function of the device must be used for this purpose (see chapter Deleting Data in these Instructions for Use).

If MediCapture notices that personal data is stored on the device, or if there is only reasonable suspicion that this is the case, the device will be returned at the expense of the user and the user will be instructed to re-send the device in the condition described hereinabove.

If a software update is installed on the device, data will only be transmitted to the device and not vice versa.

Intended Use:

This device is intended to record video and images from a variety of medical imaging systems.

The intended patient population are not specified for this device. The intended user occupations are doctors or nurses, ages between 20 - 59, education level college or university level or above.

Contra Indications and side effects:

Contraindications directly related to the product are presently unknown. On the basis of the patient's general condition the doctor in charge must decide whether the planned use is possible or not. For further notes and instructions please refer to the latest medical literature.

General Functional Description:

MVR / MVR Pro is a medical grade, High Definition Video Recorder. MVR / MVR Pro does not feature any applied parts that come in contact with the patient. It is an assistive tool with no medical application to patients when using the device.

MVR / MVR Pro can be operated by using the integrated touchscreen monitor, an external touchscreen monitor, the front panel buttons or the supplied IR remote control.

The version MVR does not feature the integrated touchscreen monitor.

For more details about external touchscreen monitors types, please visit www.medicapture.com

After installing all physical video connections (see section *Back Panel*), the user can store images and videos - provided by the imaging system - in real time on the internal storage, onto a USB storage media, or on a network storage. Images get stored in JPG format or PNG format; videos are stored in high quality MP4 format. Both collected formats can be viewed and stored from the USB storage to any common PC system or server for long-term storage.

Additional (optional) function:

- **4K Activation:** MVR Pro can record a 4K HDMI signal in 2160p30. (Without activation the signal will be downscaled to 1080p30).

In the Review function a user can playback and edit the recorded data within the active patient study.

After closing the study, the user has access to the Archive (internal storage or USB media) to review and edit several stored studies of different patients.

MVR / MVR Pro features multi-input recording. It automatically detects the input resolution of both possible video inputs. For this reason, the MVR / MVR Pro must be switched on before the signal sources are activated. If two signals are detected, an additional icon appears on the monitor. The user can toggle between these signal sources during the active patient study. For more details, see section *Changing Input Signals in Live View*.

Please note: MVR / MVR Pro features powerful functionality in minimized mechanical dimensions.

Passive cooling results in an inaudible, fan-less design. The device will be very warm to the touch, which is normal. MVR / MVR Pro operates across the full temperature range from -20°C to 40°C.

MediCapture recommends an installation in a location where air can provide proper cooling. It is not recommended to stack MVR / MVR Pro with converters or other warm devices.

First installation / General preparations for safe operation and performance:

1. Connect to the power cord to the back of the device.
2. Connect a network cable to LAN – if required.
3. Connect a camera with an HDMI output connector to the matching MVR / MVR Pro HDMI input connector. It is recommended to keep any cable connections as short as possible to avoid electromagnetic interferences caused by cables.
4. Prior to recording images and video for the first time, it is recommended to check the initial settings found in the INFORMATION Page .

As long as no patient study was started, this INFORMATION page gives you access to MVR / MVR Pro Settings .

The following settings are recommended to be checked prior to the first use of MVR / MVR Pro:

a) User Interface Language

- Settings ➤ System ➤ Language

Note: You can select the touch keyboard layout (language) every time the touch keyboards appears. Simply tap on the “globe” icon  to change the layout.

b) Time Zone, Date and Time

- Settings ➤ System ➤ Date and Time

c) Patient Information definition

- Settings ➤ System ➤ Patient Info

d) Set Network settings. For Network storage, the MVR Remote App and network printing, please use Auto-IP setup or Manual IP setup.

- Settings ➤ Advanced ➤ Connections ➤ Network

e) Network Storage properties. Set properties of your shared folder on the network storage target.

- Settings ➤ Advanced ➤ Connections ➤ Network Storage

f) Storage target selection. For Multi-Storage you can select two* options. This setting is *very important* as it also defines your Review options in the Archive and search options for existing Patient Information.

- Settings ➤ System ➤ Storage

g) Video quality and codec format H.264* or HEVC*

- Settings ➤ Video/Audio ➤ Recording Quality

h) Photo format JPG or PNG

- Settings ➤ Video/Audio ➤ Photo Settings

i) User Accounts. You can define User Accounts with specific passwords to protect the device and data from misuse.

- Settings ➤ Advanced ➤ User Accounts

j) Printer Selection and Number of Print Copies Please ask your IT-Administrator to connect MVR / MVR Pro to LAN network or Wi-Fi connection first.

- Settings ➤ System ➤ Printer

k) Audio-Recording ON/OFF and microphone selection

- Settings ➤ Video/Audio ➤ Audio Input

Checks before you operate the device:

The operation of this device does not require special maintenance, calibration, special hygienic precaution or the use of consumable components.

Start:

1. Insert the supplied MediCapture USB flash drive in the front panel. (Connect USB flash drive and all external pointing devices first, e.g., mouse, keyboard, touch screen, etc. before switching on the device from the back panel.)
2. Turn on the unit from the back panel power switch.
3. Turn on your camera system(s) after MVR / MVR Pro has started its boot sequence.
4. Use your imaging equipment as you normally do.
5. Tap on the Start field to create a new patient folder and to either select a patient from a list or to type in patient information. Choose Capture Photo or Record Video by pushing the corresponding button. Press again to stop recording.
6. When you wish to end the study, press the END OF STUDY icon on the touchscreen  [or “F3” on your keyboard]. Afterwards, you can either finish the study or review and edit.

If you wish to continue with the last active study, please tap on the upper return icon  [or “ESC” on your keyboard] to go back.
7. When you finished the study, it is safe to remove the USB flash drive from the MVR / MVR Pro. Insert the stick into the USB connector of a computer. Drop and drag your recordings from the stick to your computer for viewing, archiving, etc.

Note: Do not remove the flash drive from MVR / MVR Pro while recording!

Compatibility to Other Devices

The compatibility list for medical video sources can be found in “**Appendix A: MVR / MVR Pro Specifications**”, in this document.

Video input signal specifications for video sources and Video output signal specifications for monitors to display the user interface (also external touchscreen monitors for optional operation).

Touchscreen Monitor

MVR Pro only

The integrated touchscreen monitor serves to operate MVR Pro and for easy access to settings.

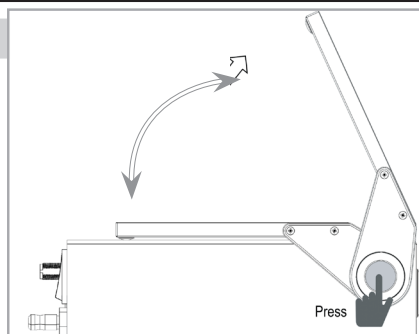

The touchscreen position can be changed by pressing the release button on the left side.

Front Panel

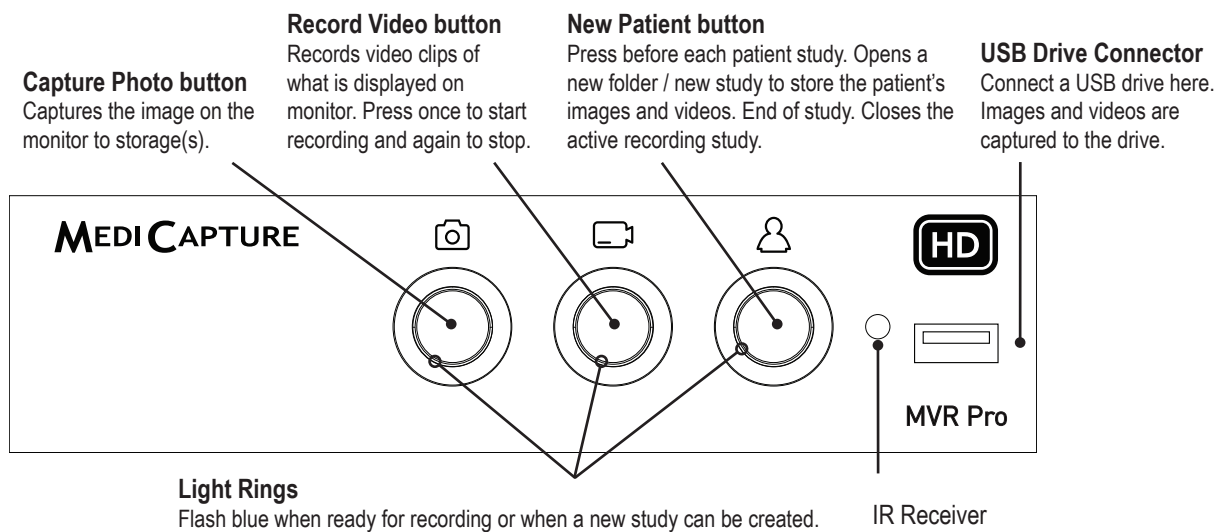

Blue LED light ring indicates which function is available at the moment.

Back Panel MVR / MVR Pro

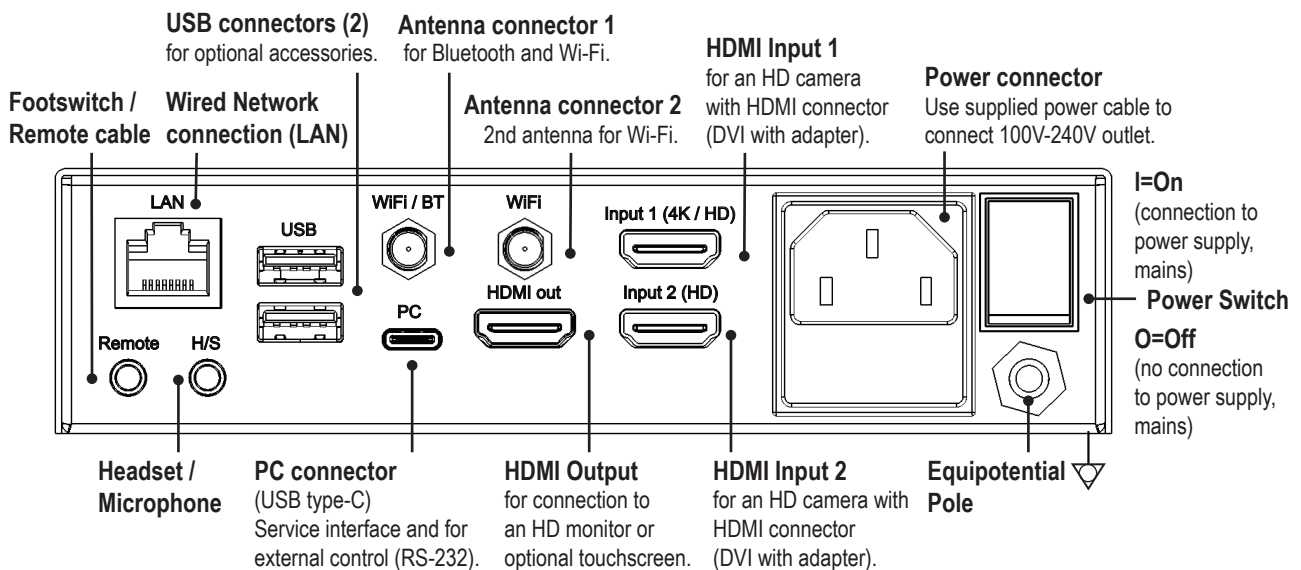

If you want to enable Wi-Fi or Bluetooth in the settings, please connect the supplied antenna to connector 1.
No antenna from another manufacturer or supplier may be used for this purpose.



The unit is for exclusive interconnection with IEC60601 certified equipment in the patient environment and IEC60XXX certified equipment outside of the patient environment.

A certified power supply cord set must be used with this equipment. The relevant national installation and/or equipment regulations shall be considered. The power supply cord shall be not less robust than an ordinary tough rubber-sheathed flexible cord according to IEC 60245 (designation 53) or ordinary polyvinyl chloride sheathed flexible cord according to IEC 60227 (designation 53).

Monitor User Interface

MVR / MVR Pro displays easy-to-use icons. Icons can be tapped directly on the touchscreen.

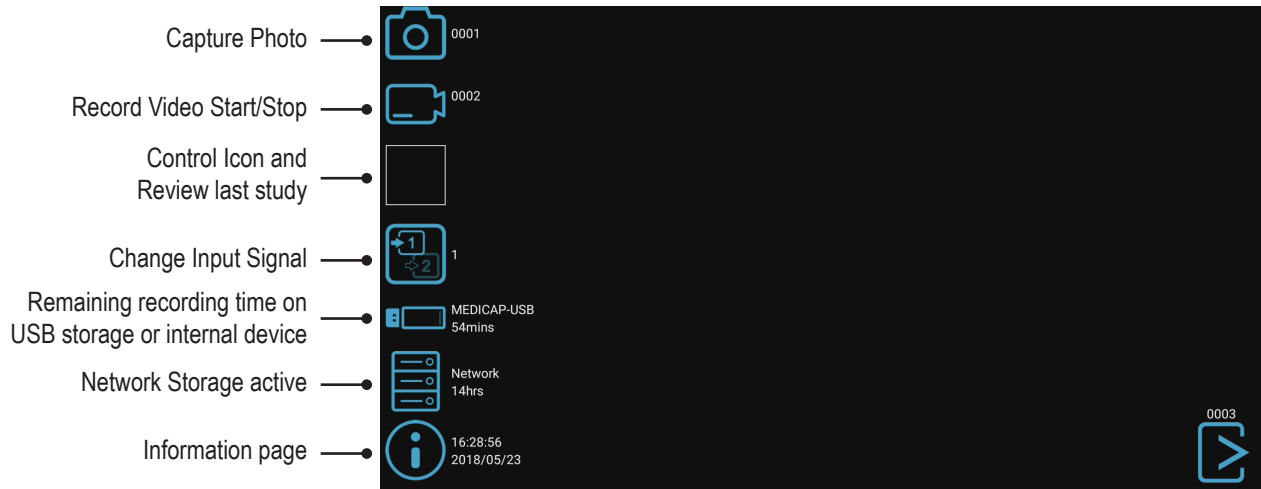

MVR / MVR Pro live view screen. This is the icon size, displayed on a Full-HD monitor.
On a 4K monitor, the icons will appear smaller.

Please note:



The position of the icons in live view can be arranged to your preferred location. Simply swipe the icons to the left or the right for position change.

If you do not wish to see the icons on your monitor, you can easily swipe them out of the visible monitor area.

Swipe the icons with one finger, when using a touchscreen monitor.

USB keyboard with integrated trackpad

A USB keyboard with integrated trackpad can serve as an alternative to a touchscreen monitor. The integrated trackpad works like a mouse with double-click function.

Please note the short cut key functions to operate the user interface of MVR:

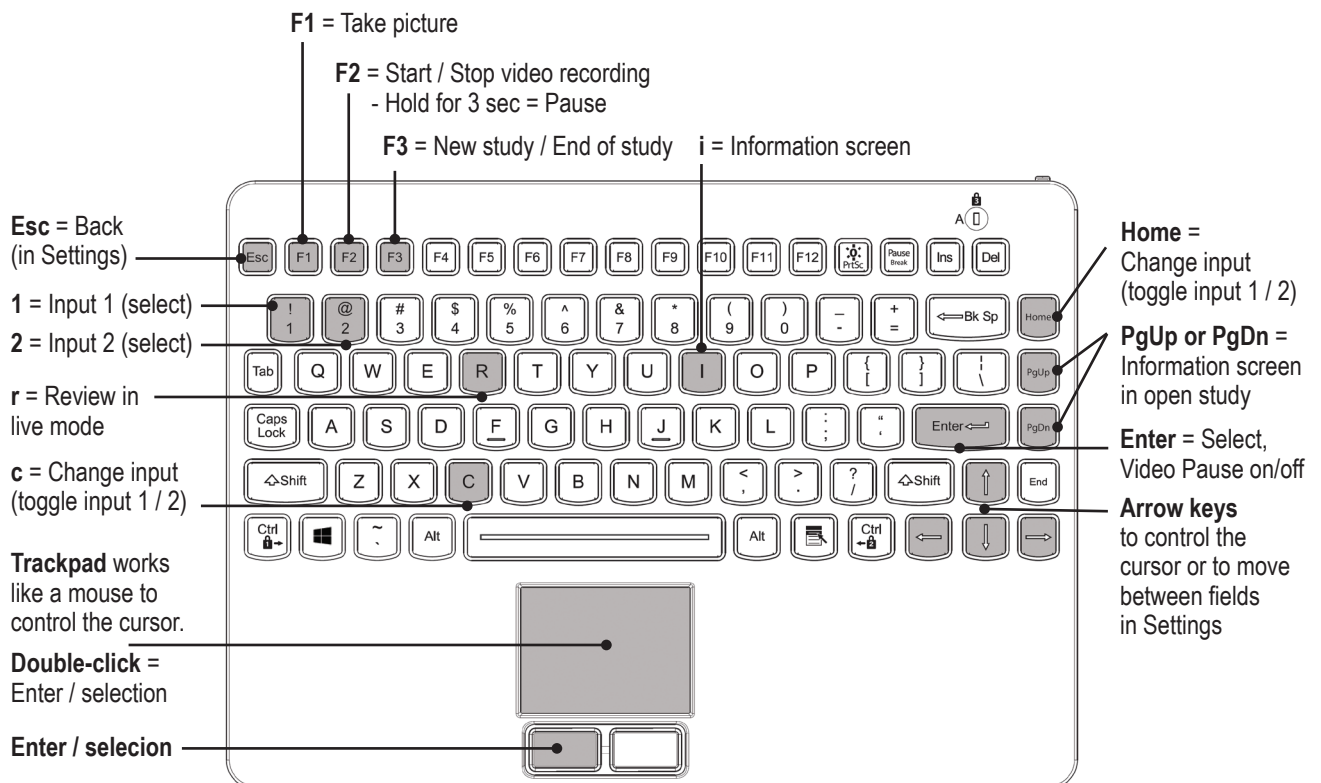

Remote Control

Important:

Remove remote's battery protective tab or insert the battery before using.

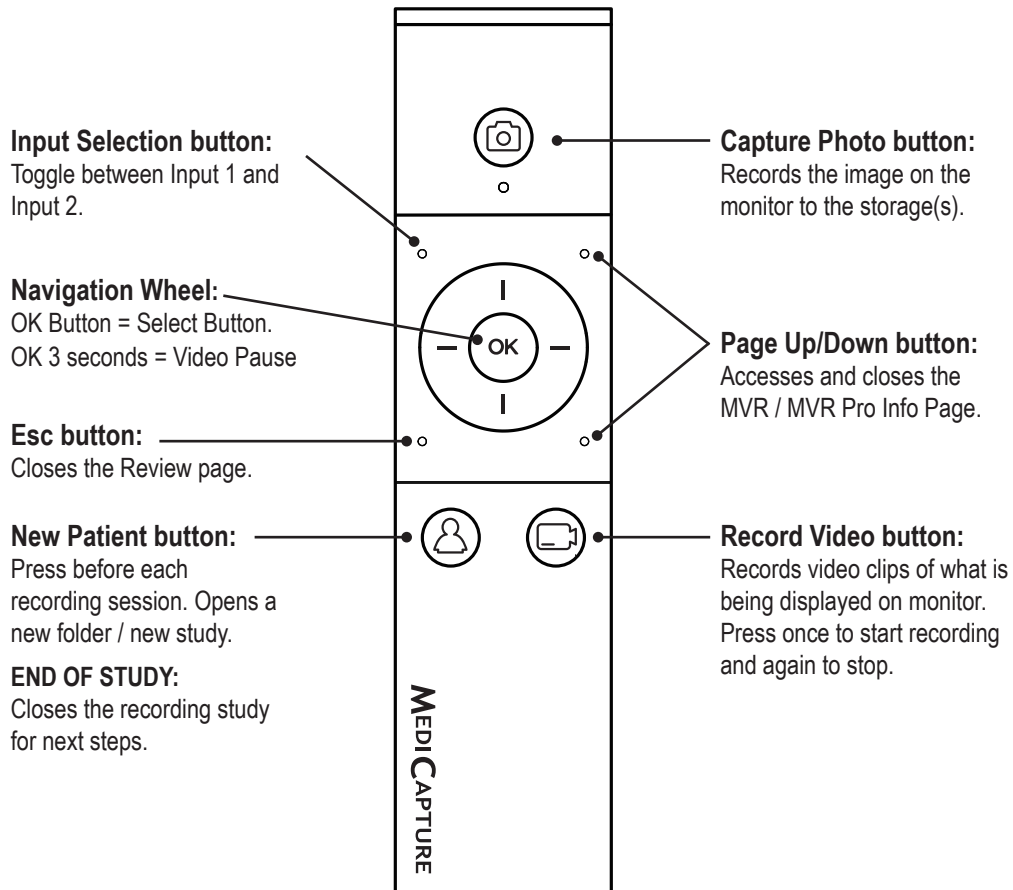

Remote control with a Remote Device (tablet) by using the MVR Remote App

Android remote devices (tablets) can be used for external control of MVR / MVR Pro, either via USB connection as an external touchscreen monitor (= USB tethering) or wirelessly as a handheld portable device.

MediCapture recommends to use pre-installed and tested MediCapture tablets.

Example: TBHI9PRO – MVR Remote Tablet

For further instructions about setup and use of a tablet as a remote control, please contact MediCapture to obtain the additional document *Instructions for Use Supplement, Tablet*.



Connecting the MVR / MVR Pro

The MVR / MVR Pro connects to one or two video sources (for example, an endoscopic camera, surgical camera, ultrasound, etc.).

1. If you are adding the MVR / MVR Pro to imaging equipment that you are already using, begin by locating the video output of the primary video source.
2. Connect the appropriate cable between the video output on the video source and the appropriate video *input* on the back panel of the MVR / MVR Pro.
3. Plug in the power cord.
4. You can also connect standard footswitches or camera triggers to the back panel. A footswitch or trigger can be used to capture photos. Connect the footswitch or trigger to the “Remote” connector. By tapping the footswitch or trigger, it will perform the same function as pushing the *Capture Photo* button on the front panel.

Please note: To operate two remote cables from your image source (Capture Photo + Record Video) an adapter is necessary for the MVR / MVR Pro remote connector.

Footswitches are available as an option at medicapture.com.

Note that for a camera trigger to be compatible with the MVR / MVR Pro, it must be of the simple “closed-contact” type, not a “programmable” type of trigger.

Inserting a USB Flash Drive

The easiest way to get started is to record to the supplied USB flash drive.¹ Insert the flash drive in the front USB port. MediCapture brand flash drives are recommended.

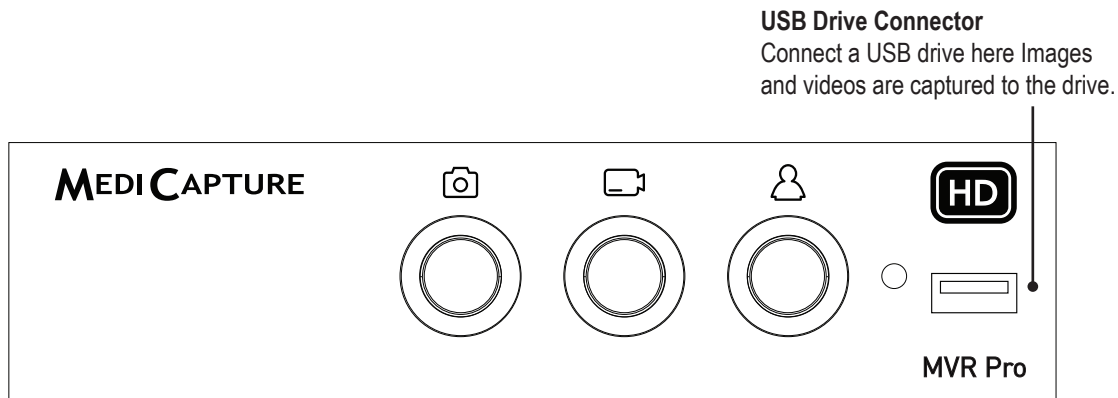

¹MediCapture brand flash drives come in a variety of models.

Creating Patient Data

The workflow for patient data input depends on the settings for Patient Info. > Settings > System > Patient Info
 MVR / MVR Pro starts with a defined home screen after switching-on or after a study was finished.

Workflow after MVR / MVR Pro was switched on:

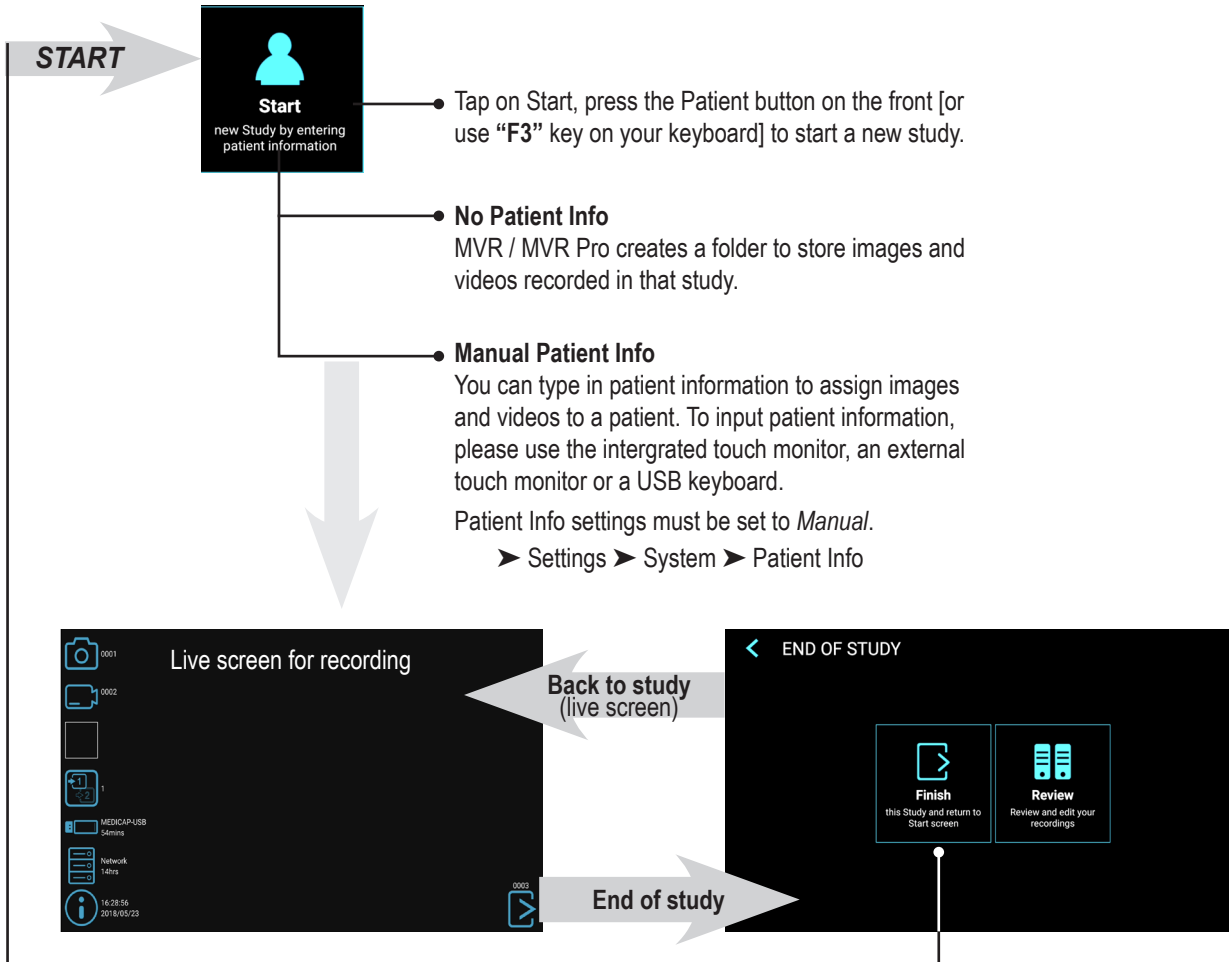

Using Patient Button to End Recording Study

You can use the Patient button on the front to finish a study.

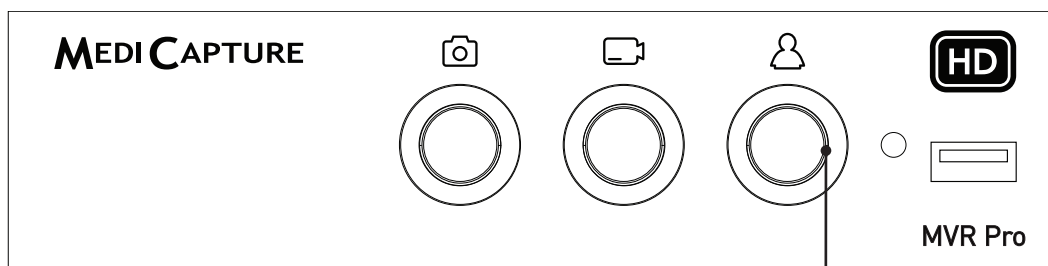

Light Ring
Is illuminated blue when a recording study can be closed (END OF STUDY)

Manual Patient Data Input

You can type in patient information to assign images and videos to a patient. Patient info settings must be set to *Manual*.

► Settings ► System ► Patient Info

Tap on **Continue** to start your new study.

Search Recent Patient on Storage



Instead of typing patient data manually, you can also list all recent patients which are located on your MVR / MVR Pro storage media (those which are enabled and connected). Tap on the “search” icon in the screen “ENTER PATIENT DATA” to retrieve the list.

Select existing patient data and tap again to copy the patient data to your new study. You can still change these data.

Date	Patient ID	Name	Birth date	Gender
2018/08/13	123JB4567	Bloggs, Joe	1958/05/12	M
2018/08/13	0123GS14...	Goodman, Saul	1965/12/04	M
2018/08/13	123SS5567	Smith, Sandra	1969/12/07	F

Capturing Images



To capture an image, tap on the *Capture Photo* icon on the touchscreen.

Front panel: Press the *Capture Photo* button on the front panel. [USB keyboard: Function key “F1” has the same function.]

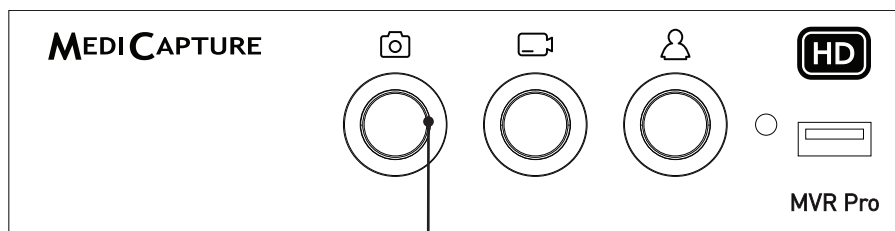

Light Ring

Is illuminated blue when the device is ready for capturing images. Goes out briefly when capturing images.

Recording Videos



To start recording video, tap on the *Record Video* icon on the touchscreen. Tap icon again to stop recording.

Front panel: Press the *Record Video* button on the front panel. Press the button again to stop recording.

[**USB keyboard:** Function key “F2” has the same function.]

Recording tips:

- You can capture still images while video is being recorded. Simply tap/press the *Capture Photo* button while a video recording is in progress. When reviewing a video file, you can see tags in the timeline. These tags are helpful to identify when a picture was captured during recording.
- Long recordings are automatically divided into files of 4GB each. This ensures that files are kept to a manageable size. The process is “seamless.” When making a long recording, you will not notice when a new file is automatically started. When playing back a long recording using “continuous play” (a feature in most media players), there will be no gaps in playback.

More information
about tags
in chapter:

*“Reviewing Videos
on MVR / MVR Pro”.*

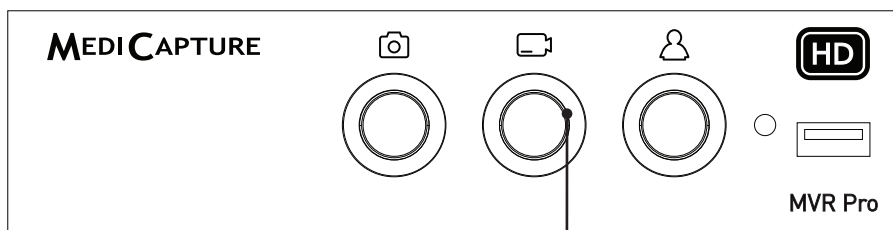

Light Ring

Is illuminated blue when the device is ready for recording videos. Flashes blue while recording.

Pausing a Video Recording



To use *Pause* you have to enable the function in Settings

➤ Settings ➤ Video/Audio ➤ Recording Options

The *Pause* icon will appear in the live screen after *Pause* is enabled.

To pause a video, tap on the *Pause* icon on the touchscreen. To continue video recording, tap the *Pause* icon again.

Alternative operation:

To pause a video while it is recording:

- Press the *Record Video* button on the front panel for 3 seconds.
- You can also use the OK button of the Remote Control.
- [**USB keyboard:** Holding key “F2” for 3 seconds or “Enter” has the same function.]

The Light Ring flashes in a very fast sequence when the video recording is paused.

To continue the video recording:

- Press the Record Video button or OK button of the Remote Control again.
- [**USB keyboard:** Pressing “F2” or “Enter” has the same function.]

The Pause function is used to create only one video file with content of different sections. It can be used multiple times during one video recording to eliminate “unwanted” parts. When reviewing a video file that was paused, you can see tags in the timeline. These tags are helpful to identify the different sections of the video.

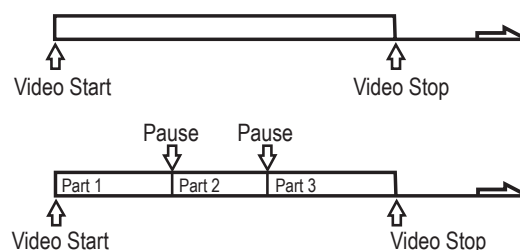

More information
about tags
in chapter:

*“Reviewing Videos
on MVR / MVR Pro”.*

Changing Input Signals in Live View = Multi Input



If two cameras are being connected, MVR / MVR Pro detects both input resolutions and displays an additional icon on the monitor. You have the option to change between Input 1 and Input 2 at any time during one imaging session (patient study). Any active video recording must be stopped first.

- By using a touchscreen monitor simply tap on the Input button to toggle between both signals.
- Alternatively, you can use the remote control button for toggling the Input.
- [USB keyboard: Pressing “c” has the same function.]

Storage Options = Multi-Storage

➤ Settings ➤ Archive ➤ Storage

MVR / MVR Pro offers the possibility to store your recording studies to multiple storage targets.

Note: Two types/options of storage can be chosen at the same time.

Options are:

- Internal Storage
- USB Storage
- Network Storage

You can also select different video resolutions for different storage targets.

Example: Recording to USB in the highest possible resolution and recording to a network server in reduced resolution.

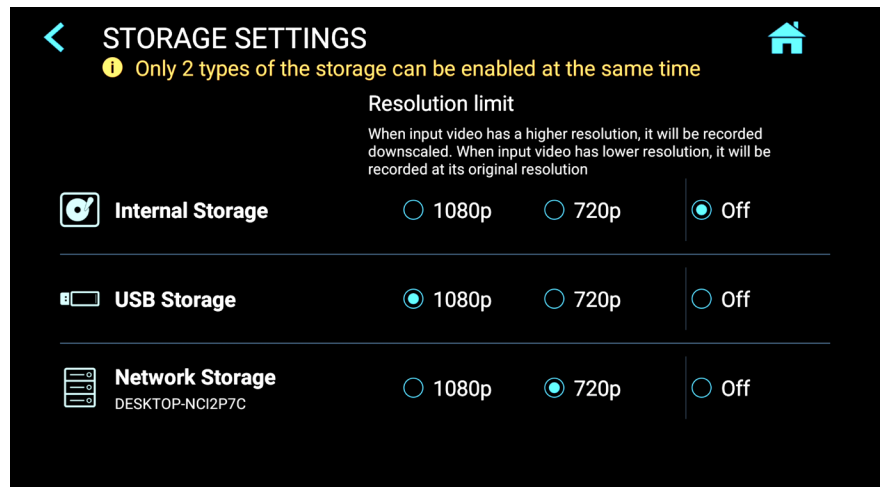

Note: Images are always captured in the original input resolution.

Resolutions 1920x1200 and 1280x1024 will be supported at setting 1080p – recorded and captured in original resolution and format.

Recording to a USB Flash Drive

Recording to the supplied MediCapture USB flash drive is the easiest way to start using your MVR / MVR Pro. When you finish recording, you can remove the flash drive and easily carry it with you.

Please make sure that USB storage is activated.

➤ Settings ➤ Archive ➤ Storage

USB Drive Connector

Connect a USB drive here. Images and videos are captured to the drive.

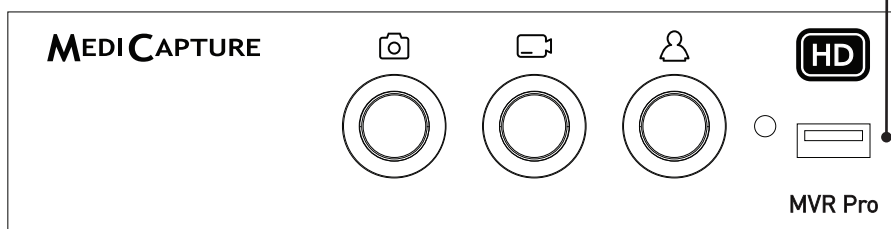

Note: In case the policy in your IT-environment does not allow the use of USB storage media at all, IT-Administrators can disable the USB-option for storage.

➤ Settings ➤ Advanced Settings ➤ Storage Rules

Recording to a USB Hard Drive

Recording to a USB hard drive is very similar to recording to a USB flash drive. The primary benefit to using a USB hard drive is that it can provide much greater storage capacity than a USB flash drive. Before using a USB hard drive with your MVR / MVR Pro, note the following:

- Delete any software that came pre-loaded on the drive (it may be incompatible with the MVR / MVR Pro).
- To protect your videos and images, it is important to back them up by transferring them from the external hard drive to your computer or network.
- Due to the large capacities of external USB hard drives, it will take the MVR / MVR Pro approximately 20-60 seconds to recognize the device. Please be patient and wait until the external hard drive has been recognized. The external hard drive has been recognized when the *New Patient* backlight becomes illuminated and the USB icon appears on the connected monitor.

CAUTION:
After inserting the external hard drive, DO NOT UNPLUG! Wait at least one (1) minute allowing the system enough time to recognize the external hard drive.

Hard Drive Formats

USB hard drives come in different “formats”: FAT32, NTFS or exFAT. The MVR / MVR Pro can process all three formats. In case of non-recognition of the USB hard drive, it may be helpful to format the drive to FAT32.

Note: The automatic video repair function does not work with the file format exFAT. MediCapture recommends to use hard drives in format FAT32 or NTFS.

How to Determine the Format of a USB Hard Drive:

- Plug the drive to a Windows computer.
- Right-click on the drive icon and select “Properties”.
- In the general tab, the File System (format) will be listed.

Transferring Images from a USB Drive to Your Computer

1. If you record your videos to a USB flash drive or USB hard drive, unplug it from the MVR / MVR Pro at the end of your imaging studies. Insert the drive into a USB connector on your computer.

Note: Do not remove the flash drive from MVR / MVR Pro while recording! Your recording file may get corrupted.

2. The computer will manage the USB drive just like any other drive on your computer. Navigate to the drive and open it so you can see the folders it contains.
3. You can click on the images and videos to review them while they are on the drive, or you can move them to your computer’s hard drive and review and store them there (recommended). Refer to Windows or Mac OS documentation for information on how to access drives on your computer and manage files.

Recording to Internal Storage

Recording to internal storage as a second option improves safety of your stored data as you always create a backup recording. Please do not consider the internal storage as a long-term storage. Even the biggest internal memory will eventually fill to capacity. Best practice is to clear the cache on a regular basis.

MVR / MVR Pro offers functions to clean the internal storage automatically. Rules to clean internal memory should be set by your IT-Administrator.

➤ Settings ➤ Advanced Settings ➤ Storage Rules

Recording to Network Storage

Recording to network storage is the best option for long-term storage. Images and Videos are recorded in real-time and in standard formats to this external mass-storage.

Please ask your IT-Administrator to setup the settings for network storage.

1. Create a physical LAN connection to your Network server by using the network connector on the rear of MVR / MVR Pro. Alternatively you can setup a Wi-Fi connection to your Wi-Fi router.
 - Settings ➤ Advanced ➤ Wi-Fi
2. For wired LAN connection: Choose IP settings Auto-IP setup or Manual IP setup.
 - Settings ➤ Advanced ➤ Network
3. Properties for the Network storage server.
 - Settings ➤ Advanced ➤ Network storage server
4. Storage settings for Network storage (activation and resolution limits).
 - Settings ➤ Archive ➤ Storage

Reviewing Studies on MVR / MVR Pro

You can review your active study from the live recording screen. This is helpful to control your recordings before you finish this study. Video recordings must be stopped before changing to Review.

Tab on the Review icon to enter Review. Closing the Review screen brings you back to your live recording screen.



Archive

The Archive offers intuitive features to browse your recorded studies. You can enter the Archive from the Start screen. Both enabled options for Multi-Storage can be accessed in Archive. All enabled options need to be connected to MVR / MVR Pro.

Available features in Archive:

- Review images and playback videos
- Delete files
- Delete empty studies
- Take snapshots from paused videos. Paused videos can be moved frame by frame
- Delete video sections at the beginning and/or the end, cut video in multiple parts and store as new combined video. (As of firmware version FW 191018)
- Edit images with annotations and store them as new image
- Magnify or crop images and store them as new image
- Copy complete studies, single images or single videos to USB
- Select images and print them on a report
- Send reports to a network printer or store them as PDF file

Select one storage. Internal, USB or Network

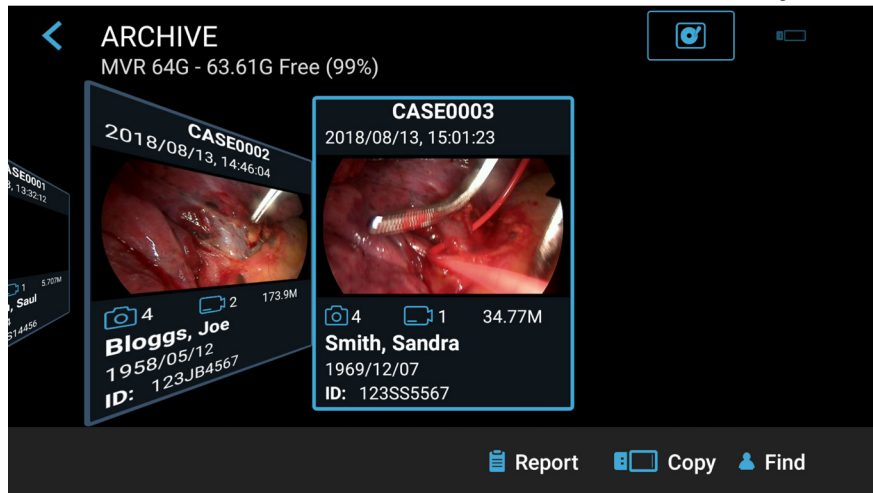

Tap on study for selection

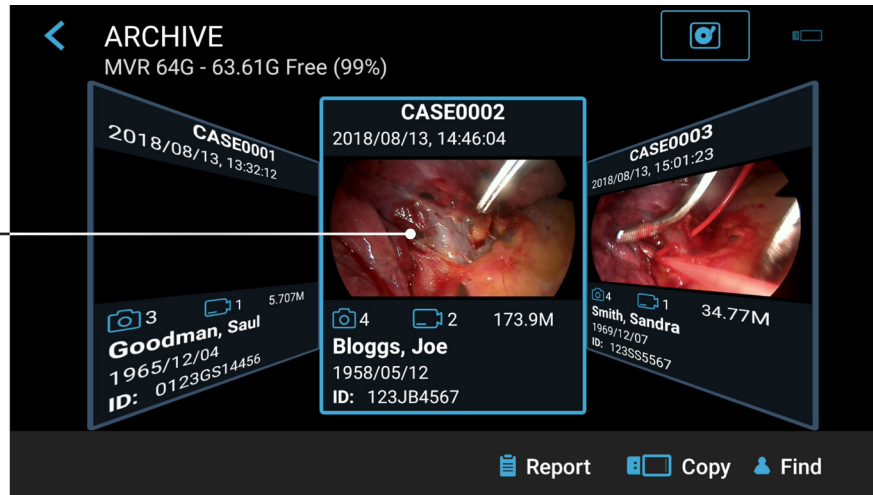

To select a study, a video or a still image, simply tap on the preview icon.

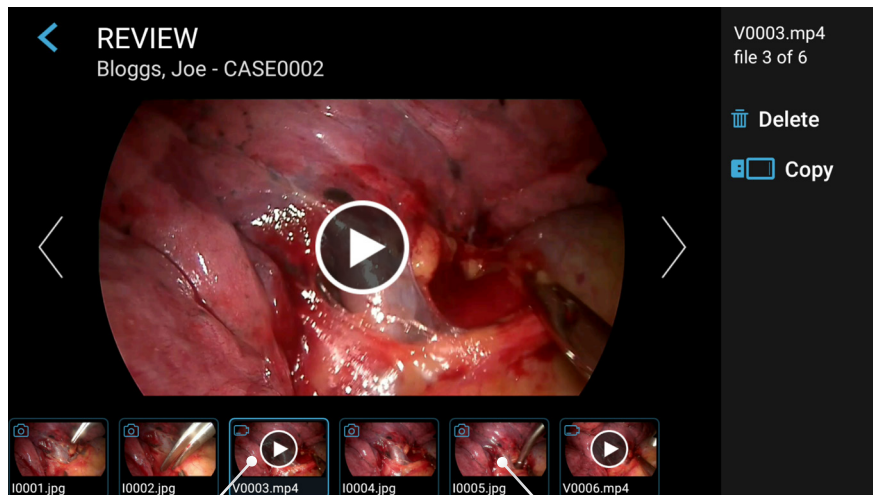

Tap on video for playback

Tap on image for editing

Deleting Data

Data on selected storage media can be deleted individually. Your confirmation of each deleting activity is requested on the screen.

- **Deleting single files** (pictures/videos): Select the file you want to delete and tap on the delete icon.
- **Deleting of a complete study** is possible, as soon as it is empty – all files were already deleted.
- **Clearing of all data** from the device storage. Please use the formatting process to delete all data from directly connected storages (USB memory or internal memory):
 - Settings ➤ Advanced ➤ Update & Default

Note: When using the formatting process, all data is deleted and cannot be recovered!

Reviewing Videos on MVR / MVR Pro

A selected video starts to play automatically. To pause the video, tap on the Pause icon. You can now use the timeline slider to change position in the video or tap forward and backward frame by frame.



You can magnify the paused video by using two fingers.

If you want to take a snapshot of the paused video, tap on the Photo icon.

This captured image will be added to the patient study.

You may see tags in the video timeline. Tags get created every time:

- the video is paused during recording
- an image is captured during recording
- the video signal lost synchronization for less than 10 seconds (most probably caused by a damaged video cable)

You can jump between tags by using the blue forward/backward icons.

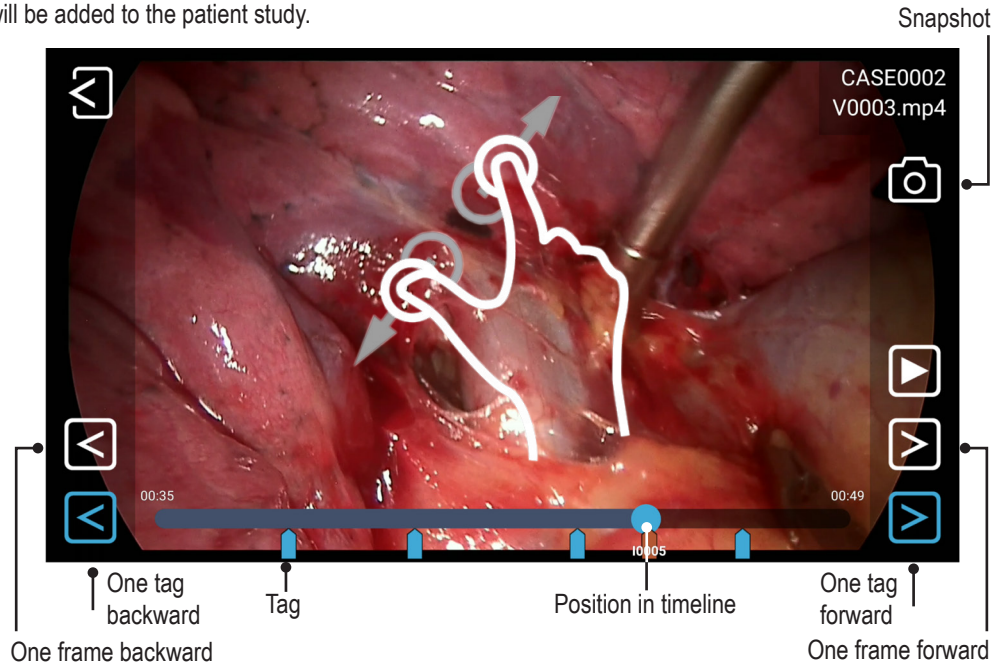

Reviewing Still images on MVR / MVR Pro

A selected image can be edited in many ways and stored afterwards as a new image to the study.

Options are:

- Magnification / cropping
- Adding text notes
- Marking areas with circles, squares or freehand drawings
- Adding notes to the image file which will appear in reports

Note: To discover all options for editing, please watch our demonstration videos at medicapture.com

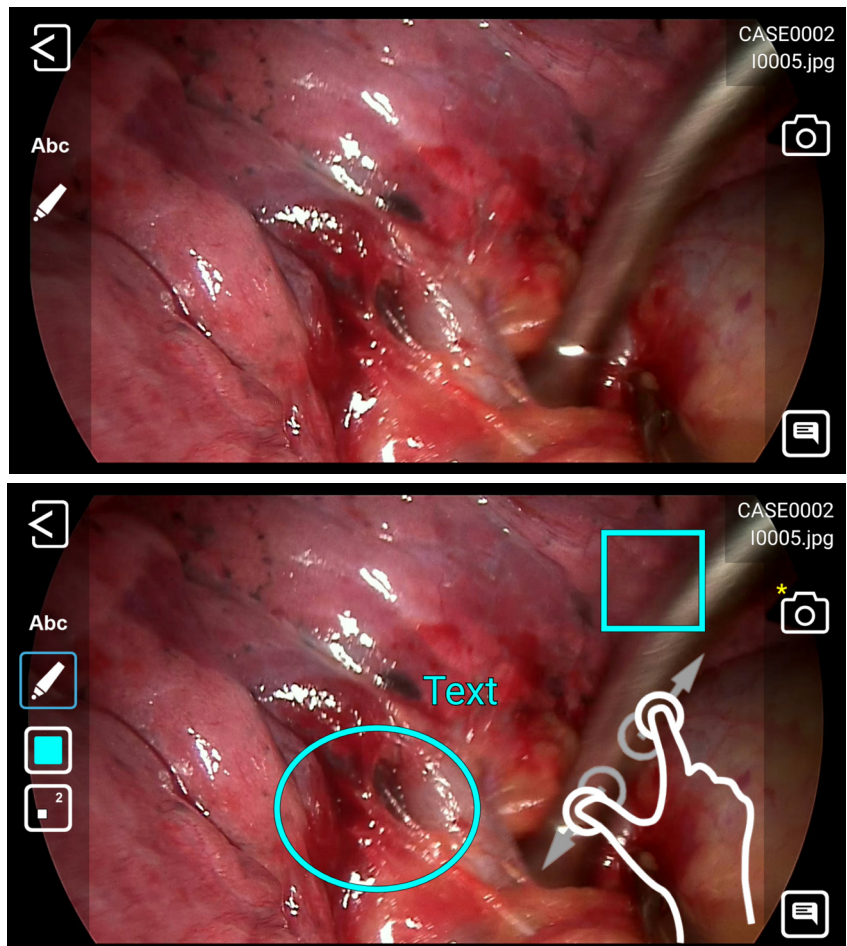

Creating and Printing Reports

Still images of a selected study can be saved as a PDF report. You can add notes which will appear on the report. The PDF report will be stored into the same folder as your images and videos. The report can also be printed with a network printer*.

All selected images will appear in the report.

By tapping on the upper icons you can change the layout of the report (number of images per page, arrangement) and select the number of copies.

* Please ask your IT-Administrator to connect a network printer or a local Wi-Fi printer and to setup the printer properties.

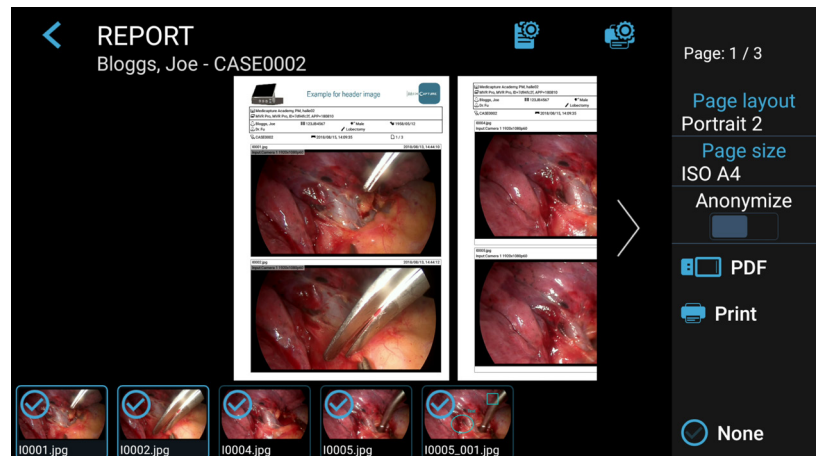

Report Header Image

You can import a header image to personalize the report. This image will appear on top of the first page of your reports. Recommended header image size is 1600-3200 pixels in width. Recommended height is 200-1000pixels. PNG or JPG files can be used for the header image.

Viewing Still Images on Your Computer

You can easily view the recorded images that you have transferred to your computer. Windows and Mac computers provide built-in viewing software that will open automatically when you double-click on an image file. You can also view and edit your still images using specialized medical image management programs available from many third-party vendors.

Viewing Videos on Your Computer

The MVR / MVR Pro records high definition video in H.264* or HEVC* (=H.265) format, sometimes referred to as MPEG-4 or MP4. These widely used formats are ideally suited to medical applications because they deliver the highest quality video in a compact file size. New Windows and Mac computers provide built-in viewing software that will open automatically when you double-click on a video file. However, some older computers may need additional software to play H.264* / HEVC* videos. For example, on Windows XP and Vista computers, playback is enabled by installing a simple “add-on” to Windows Media Player. For information on how to install this “add-on”, please visit medicapture.com/support.

Other Features

Capturing Images While Recording Videos

While video is being recorded, you can also record still images; simply press the *Record Photo* button as you normally would.

Creating Tags in Video Files

Tags are helpful markers in your video file to identify important events. Tags get added to the video time line when:

- an image was captured during video recording
- the video recording was paused and continued
- the video source has lost synchronization for a short moment (probably by a damaged cable etc.)

MediCapture Automatic Video Repair Function

USB drives **must not** be removed during recording! Removing the USB drive during recording results in corrupted files.

Turning MVR /MVR Pro off or a mains power failure during active video recording will also cause corrupted video files.

MVR / MVR Pro features an Automatic Video Repair Function. As soon as you plug-in a USB drive with a damaged video file, MVR / MVR Pro detects the file and fixes it for playback. A message will pop-up on the screen to inform you about the successful progress.

MVR / MVR Pro also scans the internal storage for corrupted video files and repairs them automatically.

Please note: Automatic Video Repair only works for USB drives when formatted to FAT32 or NTFS. USB drives in format exFAT are not supported by the Automatic Video Repair Function.

Footswitches and Camera Triggers

One Standard footswitch / camera-trigger connector is located on the back panel. It serves the same function as the corresponding *Record Photo* button on the front panel. Note that the footswitch / trigger connectors respond to a simple “closed contact”; they are not “programmable.”

Please note: To operate two remote cables from your image source (Capture Photo + Record Video) an adapter is necessary for the MVR / MVR Pro remote connector.

Information Page / System Settings



An Info Icon is displayed in the live screen.

By using a touchscreen monitor or a USB mouse,

you can tap on the Info Icon to access the INFORMATION page.

[USB keyboard: “i” has the same function.]

The INFORMATION page gives you an overview about relevant parameters and access to System SETTINGS.

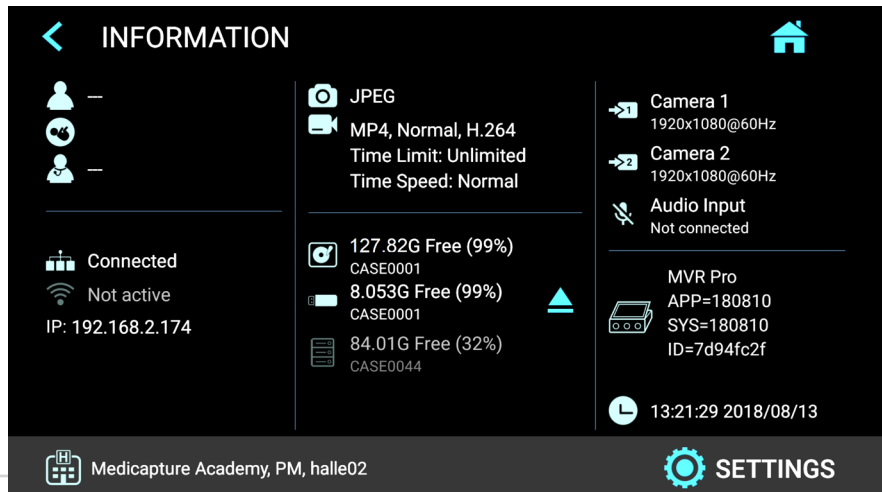

Please note:



The **SETTINGS** icon function is only available when no recording study has started. After starting a recording study, the Settings cannot be changed. If you wish to enter the system Settings, you need to close the study first. Then open the System Info page and tap on SETTINGS.

Device Info: Device ID / LAN MAC address / QR code

You can find the Device ID and the LAN MAC address by tapping on the icon for Device Info.

The Device Info also contains a QR code for scanning.

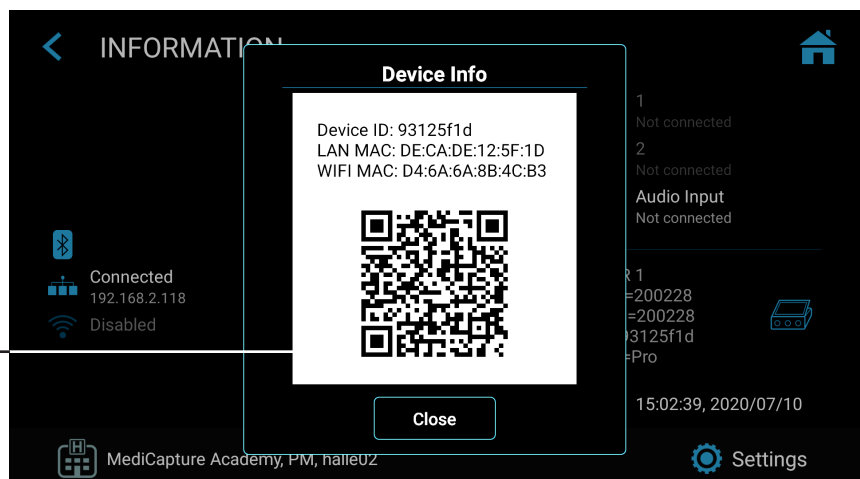

Settings (for Administrators)



You can find all MVR / MVR Pro setup features in Settings.

Please note: Advanced Settings as well as optional networking should only be changed by technical personnel or IT administrators.

SETTINGS are only available in English language.

Advanced Settings can be protected by a password. You can create your own password.

Structure of Settings:

Video/Audio

- Video Input
 - Renaming Video Input 1 and Video Input 2
 - Picture in Picture
 - Stamp function in pictures and videos
 - Parallel recording
- Recording Quality
 - Quality
 - Codec selection
- Recording Options
 - Video Time Limit
 - Time Lapse Speed
 - Pause Function
 - Pre-Recording
- Photo Settings
 - Image Format
 - Freeze on capture
- Audio Input
 - Audio activation
 - Microphone selection (voice source) Bluetooth / Wired headset microphone / USB microphone

System

- Patient Info
 - Patient Info selection (Off / Manual / CSV)
 - Location input (Hospital / Department / Location / Device title)

- Printer
 - Printer Selection
 - Number of copies
- Display (MVR Pro only)
 - Brightness
- Date and Time
 - Time zone selection
 - Date
 - Time
- Language
 - User Interface language selection

Archive

- Storage
 - Activation of USB / Internal / Network
 - Resolution limits
- Report Settings
 - Header image import
 - Page layout
 - Page size
 - Auto print report (activation)

Advanced

(can be password protected)

- Connections-
 - Network
 - Auto IP / Manual IP selection
 - Manual IP setup
 - WiFi
 - Enabeling WiFi
 - Search and connect to available WiFi

- Bluetooth
 - Activate Bluetooth and search for available devices
- Network Storage
 - Server Properties
 - Video resolution limit to network (preset for administrator)
 - Find server
 - Connection test
- Remote App
 - Analytics
- Remote Access
 - MVR IP address info
 - Remote access activation
 - Remote password configuration
 - Local storage. Enable local storage on remote device (MVR Remote App)
- Update & Default
 - Update firmware
 - Format USB storage
 - Reset settings to default
 - Reset device to factory default
- User accounts
 - User account activation
 - User account setup
- Activation keys
 - 4K recording
- Audit Trail
 - Review log files
 - Filter log files
 - Copy to USB
 - Delete log files

Locking / Protecting Advanced Settings

➤ Settings ➤ Advanced

We recommend administrators to lock the section Advanced Settings with a password.

Advantages are:

- No user has access to Advanced Settings
- The administrator can use the User Login screen (see next section) by using his password for Advanced Settings (no User Name, only Password). This opens the protected screen for Advanced Settings. It will be possible to deactivate the User accounts – in case the User account information were lost.

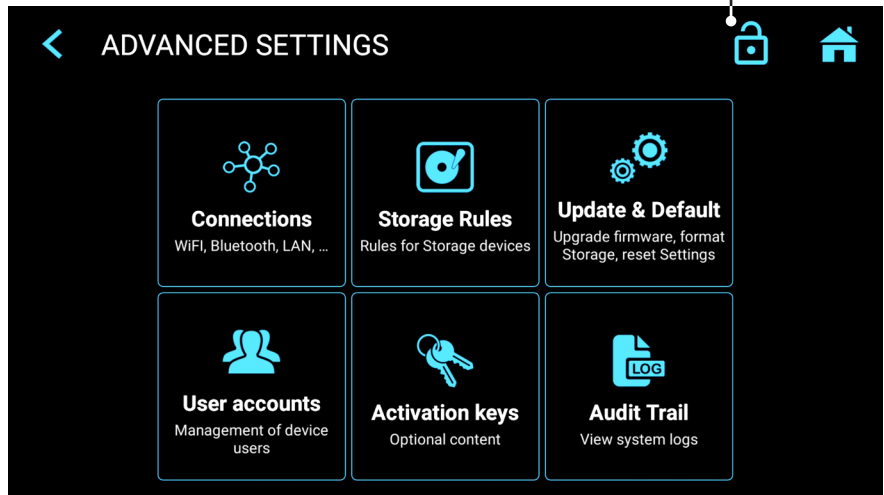
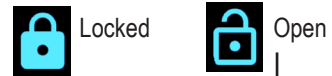

User Accounts for Security Protection

➤ Settings ➤ Advanced ➤ User Accounts

For advanced device protection and data security of recorded studies, MVR / MVR Pro can be locked with User accounts.

Enable user accounts and add users

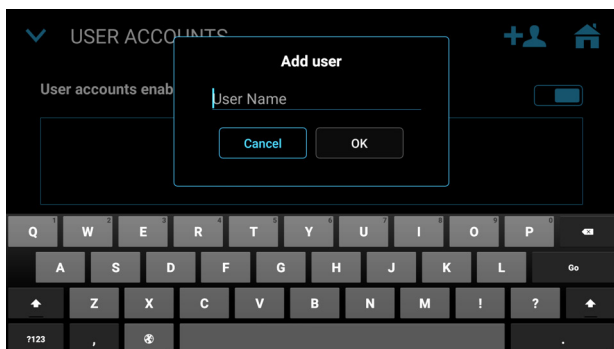
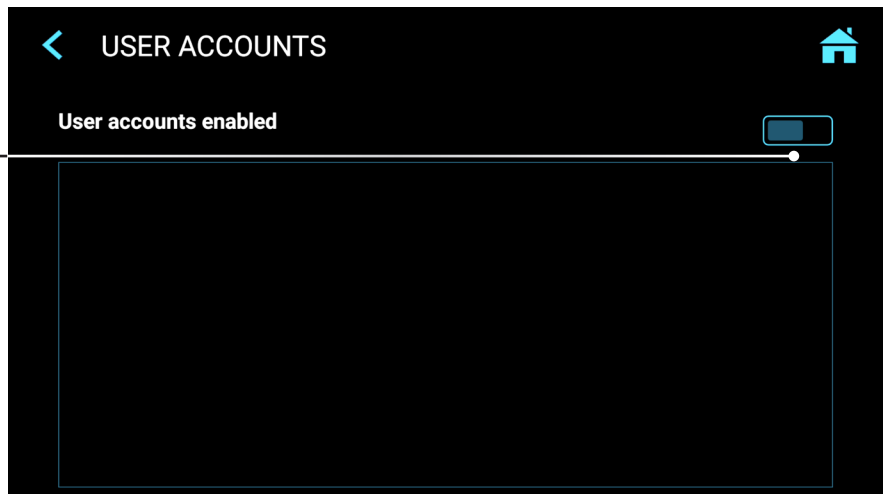

User Name

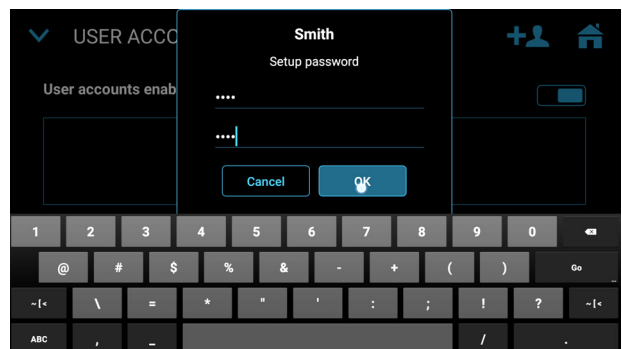

Password for User Account

Please note:

Once user accounts are enabled, you need to know your User Names and Passwords to operate MVR / MVR Pro.

MediCapture has no access to user account information and therefore, no “Master Password” exists.

In case you do not remember your user account information, MVR / MVR Pro requires a complete setup to factory default settings, which means many of your achieved information will get lost.

User log in with User Name and Password.

Note: If the User account information is lost, the administrator can login with his password, configured to lock Advanced Settings.

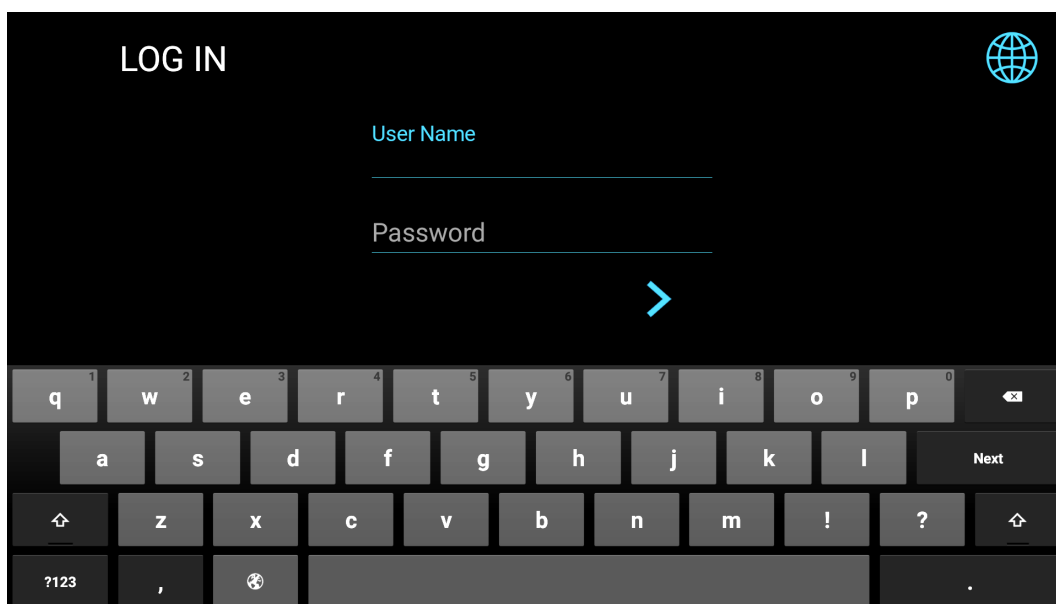

Special Video Input Settings

➤ Settings ➤ Video/Audio ➤ Video Input

Picture-in-Picture Recording (PIP)

When using Multi-Input you can set MVR / MVR Pro to *Picture-in-Picture*.

Input 2 will be displayed as a window in Input 1.

- Exactly this view gets recorded as **one** picture or **one** video into the patient study folder.
- You can choose the size and position of the PIP window.

Parallel Recording

When using Multi-Input you can set MVR / MVR Pro to *Parallel Recording*.

Both inputs, Input 1 and Input 2 get recorded at the same time when you start a recording.

- This creates **two** independent video files in your patient study folder.
- You can only see one input in the live view screen, second input gets recorded as well.

Note: You can only choose one option for Special Video Input Settings: Either PIP or Parallel recording. Both functions are limited to 1080p60 on both inputs. When a 4K camera is connected to input 1, you cannot use these options.

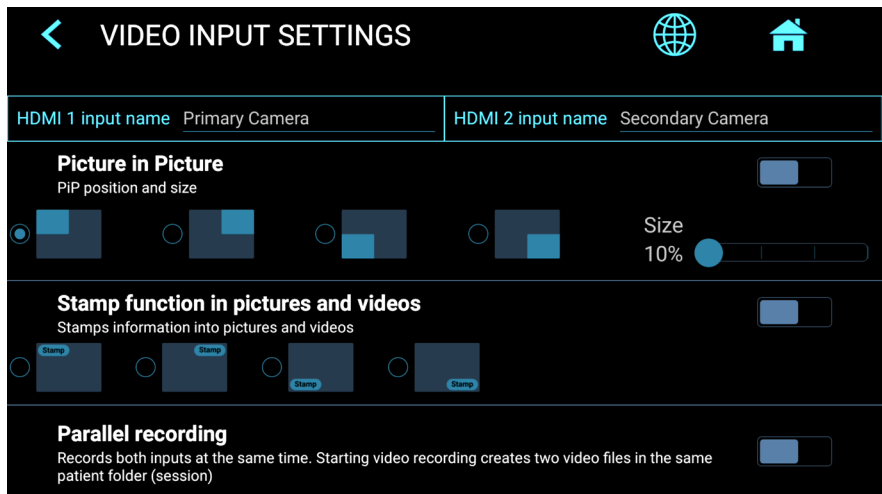

Recording Options

➤ Settings ➤ Video/Audio ➤ Recording Options

Video Time Limit

Allows you to choose time limits on recordings. For example, you can set a recording time limit of 5 minutes.

Time Lapse recording

Time Lapse recording is an option to save recording space on your storage media. It is useful for documentation of complete, long operations or processes which last over a very long period. You can take snapshots from the recorded video in the editing function of the Archive afterwards to extract important events as a captured picture.

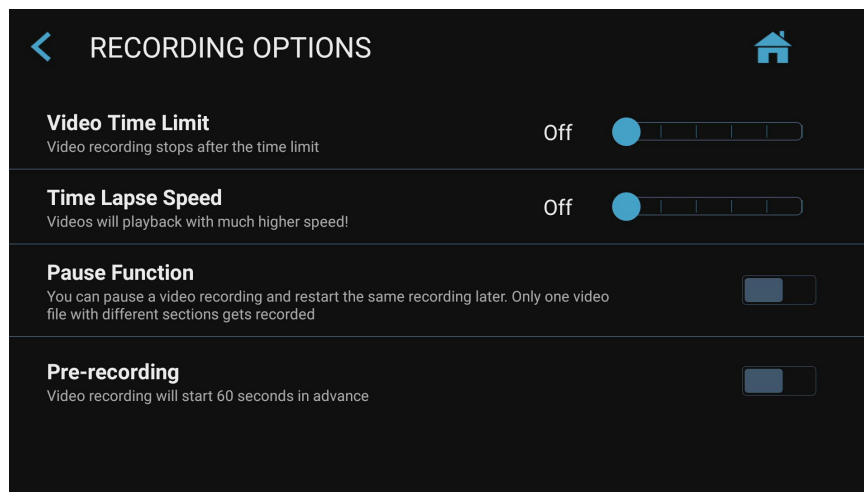

Please note: Videos recorded in time lapse mode play back in a much shorter time (depending on the time lapse speed). Do not use time lapse recording when your demand for video documentation is video playback in real-time.

You can change the speed (=factor) of time lapse recording by moving the slider.

Example: x60 will speed up video playback 60 times (1 hour of recording will be played in 1 minute).

Pause Function

You can activate the optional pause function.

Upgrades / Activation keys

➤ Settings ➤ Advanced ➤ Activation keys

4K Recording Upgrade

- MVR / MVR Pro can be upgraded to recording in a higher resolution 2160p.
- Your camera equipment should provide a signal on HDMI in 2160p30.
- If your camera equipment provides 4x 3G-SDI in Quad-Split (=Square Division) or 2-Sample Interleave format, MediCapture's additional item MVC Pro HDMI to SDI will convert your SDI-signals to HDMI.
- Please enter the 8-digit activation key.

The key is specific to the current device and cannot be used for other devices.

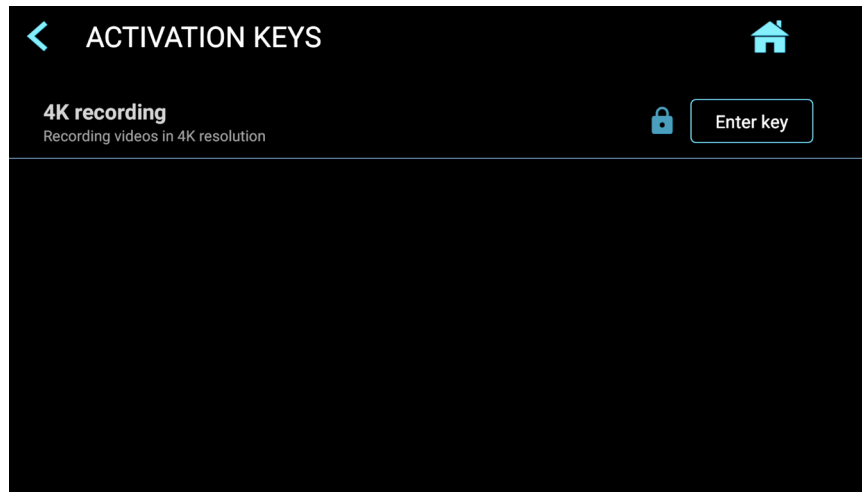

Please contact MediCapture for ordering information to the 4K activation key of MVR / MVR Pro.
The unique device ID needs to be provided (see Information screen).

Appendix A: MVR / MVR Pro Specifications

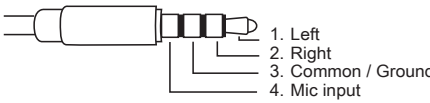
Function	Records video and still images in high definition from medical video sources to a USB storage, Internal storage or Network storage.
Case	Stainless Steel metal case, copper metal base
Buttons	Stainless Steel, fluid resistant
Video Connections	<p>Input 1 (4K /UHD): HDMI (DVI with adapter) 4096x2160p24 (4K2K), 3840x2160p30/25 (UHD “4K”), 1920x1200p60 (WUXGA), 1920x1080p60/50/30/25 (Full HD), 1080x720p60/50 (HD), 1280x1024p60/50 (SXGA), 1024x768p60/50 (XGA), 800x600p50 (SVGA), 640x400p60 (VGA) – no interlace signals on Input 1</p> <p>Input 2 (HD): HDMI (DVI with adapter) 1920x1200p60 (WUXGA), 1920x1080p60/p50/i60/i50/p30/p25 (Full HD), 1080x720p60/50(HD), 1280x1024p60/50 (SXGA), 1024x768p60/50 (XGA), 800x600p50 (SVGA), <i>*For recording 4K input signals in 4K resolution, “4K recording” needs to be activated. Otherwise 4K input signals will be recorded in HD.</i></p>
Video Output	HDMI (DVI with adapter) 3840x2160p60/50/30/25 (UHD “4K”), 1920x1080p60/50/30/25 (Full HD)
Recording Resolution	3840x2160*, 1920x1080, 1280x1024, 1280x720, 1024x768 <i>*For recording 4K input signals in 4K resolution, “4K recording” needs to be activated. Otherwise 4K input signals will be recorded in HD.</i>
Video Recording Format	MP4: H.264* / HEVC* H.265 High Efficiency Video Coding
Video Recording Bitrate	<p>H.264* coding (Adaptive Constant Bitrate): Normal quality: (HD 1080): 16 Mbps, (HD 720): 8 Mbps Super quality: (HD 1080): 32 Mbps, (HD 720): 16 Mbps</p> <p>HEVC* coding (Adaptive Constant Bitrate): Normal quality: (HD 1080): 8 Mbps, (HD 720): 4 Mbps Super quality: (HD 1080): 16 Mbps, (HD 720): 8 Mbps</p>
Image format	JPG / PNG
Sound Recording	Bluetooth microphone, Wired Headset with microphone (4 poles), USB microphone
Headset input	PIN Table: 
Internal Storage	High speed solid-state memory 128GB Larger Internal Storage by order.
External Storage	USB drives (flash drives or hard drives), FAT32 / NTFS / exFAT
USB Support	USB3.0, Super speed, 1 front connector, 2 rear connectors. Maximum allowed load to rear USB connectors is 1A.
Remote	3.5mm mini jack. Compatible with standard footswitches (not included) and closed-contact camera triggers.
LAN	RJ-45, Ethernet 10BASE-T/100BASE-TX/1000BASE-T
WLAN	Dual-band 2x IEEE802.11a/b/g/n/ac Operating bands: 2.412-2.472GHz, 5.18-5.24GHz, 5.26-5.32GHz, 5.5-5.70GHz
Bluetooth	BT4.1+HS, BLE, 2.402-2.480GHz
Firmware	Firmware updates do not affect the RF output power. This is determined exclusively by the design of the hardware components.





Mechanical	MVR / MVR Pro with touchscreen monitor: Dimensions (WxDxH): 173 x 153 x 50mm (without antenna attached), Weight: 1,28kg MVR without touchscreen monitor: Dimensions (WxDxH): 160 x 150 x 40mm (without antenna attached), Weight: 1,00kg
Environmental	Operating: ambient temperature -20° to +40° C, air pressure 700 to 1060hPa, humidity 30 to 75% (non-condensing) Storage and transportation: ambient temperature -40° to +85° C, air pressure 700 to 1060hPa, humidity 0 to 93% (non-condensing)
Protection against penetration of liquids	IP20 (= not protected)
Degree of protection in the presence of flammable mixtures	This device is not protected against explosions. (Do not operate this device in ignitable atmosphere)
Power	AC 100-240V, 0.4-0.2A, 50/60Hz, 3-prong AC jack
Fuse	T1AH, 250V
Kit Contents	MVR / MVR Pro recorder, USB flash drive, HDMI cable, Wi-Fi / BT antenna, HDMI to DVI adapter, Split Remote Cable Adapter, Power Cable, IR Remote Control, Rubber Feet (4), Instructions for Use (English)

(*) H.264 is licensed via MPEG LA, HEVC is licensed via Access Advance LLC and MPEG LA.

Compliance / Certification / Classification

Compliance and Certification	EN 60601-1:2006 + A1:2013 + A12:2014 – Medical Equipment Safety EN 60601-1-2:2015 – Electro Magnetic Compliance EMC EN 60601-16:2010+A1:2015 – Usability EN 50581:2012 – Restriction of hazardous substances This device complies with IEC/EN 62479:2010 for low power electronic and electrical equipment with the basic restrictions related to human exposure to electromagnetic fields (10 MHz to 300 GHz)
Classification	Class I Equipment / Mode of operation: continuous No AP/APG. No Applied Part.

Note: These specifications are subject to change without notice.

	Conformité Européenne (European Conformity)
	Medical – General medical equipment as to electrical shock, fire and mechanical hazards only in accordance with IEC 60601-1, ANSI/AAMI ES 60601-1 (2005) + AMD (2012) and CAN/CSA-C22.2 No. 60601-1 (2014)
	WEEE compliant RoHS compliant
	Medical Device Regulation 2017/745
	This device complies with FCC Part 15, Subpart B, Class B of the FCC emission Rules.

FCC compliance information

This product does not contain any user serviceable components. Any unauthorized product changes or modifications will invalidate warranty and all applicable regulatory certification and approvals, including authority to operate this device.

We MediCapture® Inc., 2250 Hickory Road, Suite 200 Bd., Plymouth Meeting, PA 19462 USA, Phone +1 610-238-0700, declare under our sole responsibility that the product MVR / MVR Pro complies with Part 15 Rules.

This device complies with Part 15 of the FCC Rules. Operation is subject to the following to conditions:

- (1) this device may not cause harmful interference, and
- (2) this device must accept any interference received, including interference that may cause undesired operation.

Contains FCC ID: 2AFDI-ITCNFA324

Operations in the 5.15-5.725GHz band are restricted to indoor usage only.

The antenna-to-user (bystander) separation distance must be greater than 20 cm.

Radiation Exposure Statement:

The product complies with the FCC mobile RF exposure limit set forth for an uncontrolled environment and are safe for intended operation as described in this manual. The further RF exposure reduction can be achieved if the product can be kept as far as possible from the user body or set the device to lower output power if such function is available.

Note: This equipment has been tested and found to comply with the limits for a Class B digital device, pursuant to part 15 of the FCC Rules. These limits are designed to provide reasonable protection against harmful interference in a residential installation. This equipment generates, uses and can radiate radio frequency energy and, if not installed and used in accordance with the instructions, may cause harmful interference to radio communications. However, there is no guarantee that interference will not occur in a particular installation. If this equipment does cause harmful interference to radio or television reception, which can be determined by turning the equipment off and on, the user is encouraged to try to correct the interference by one or more of the following measures:

- Reorient or relocate the receiving antenna.
- Increase the separation between the equipment and receiver.
- Connect the equipment into an outlet on a circuit different from that to which the receiver is connected.
- Consult the dealer or an experienced radio/TV technician for help.

European Union Radio Equipment Directive 2014/53/EU

Hereby, MediCapture declares that the radio equipment types MVR and MVR Pro are in compliance with Directive 2014/53/EU.

The full text of the EU declaration of conformity is available at the following internet address:

<https://www.medicapture.com/certifications/mvr409-mvr420/>

This product operates in the 2.4-2.483 GHz band with an operating RF output power less than 18.3 dBm e.i.r.p.

This product operates in the 5.15-5.35 GHz band with an operating RF output power of less than 18 dBm e.i.r.p.

This product operates in the 5.47-5.725 GHz band with an operating RF output power of less than 18 dBm e.i.r.p.

Operations in the 5.15-5.725GHz band are restricted to indoor usage only.

Industry Canada Notice

Radiation Exposure Statement:

This equipment complies with IC radiation exposure limits set forth for an uncontrolled environment. This equipment should be installed and operated with minimum distance 20cm between the radiator & your body.

Contains IC: 9049A-ITCNFA324

This device complies with RSS-210 of the Industry Canada Rules. Operation is subject to the following two conditions:

- (1) This device may not cause harmful interference, and
- (2) this device must accept any interference received, including interference that may cause undesired operation.

Ce dispositif est conforme à la norme CNR-210 d'Industrie Canada applicable aux appareils radio exempts de licence. Son fonctionnement est sujet aux deux conditions suivantes:

- (1) le dispositif ne doit pas produire de brouillage préjudiciable, et*
- (2) ce dispositif doit accepter tout brouillage reçu, y compris un brouillage susceptible de provoquer un fonctionnement indésirable.*

Caution:

- (i) the device for operation in the band 5150-5250 MHz is only for indoor use to reduce the potential for harmful interference to co-channel mobile satellite systems;
- (ii) the maximum antenna gain permitted for devices in the bands 5250-5350 MHz and 5470-5725 MHz shall comply with the e.i.r.p. limit; and
- (iii) the maximum antenna gain permitted for devices in the bands 5725-5825 MHz shall comply with the e.i.r.p. limits specified for point-to-point and non point-to-point operation as appropriate.
- (iv) Users should also be advised that high power radars are allocated as primary users (i.e. priority users) of the bands 5250-5350 MHz and 5650-5850 MHz and that these radars could cause interference and/or damage to LE-LAN devices

Déclaration d'exposition aux radiations

Cet équipement est conforme aux limites d'exposition aux radiations IC définies pour un environnement non contrôlé. Ce Cet équipement doit être installé et utilisé avec une distance minimale de 20 cm entre le radiateur et votre corps.

Avertissement:

Le mode d'emploi des dispositifs pour réseau-x locaux doit Inclure des instructions précises sur: les restrictions susmentionnées, notamment:

- (i) les dispositifs fonctionnant dans la bande 5150-5250 MHz sont réservés uniquement pour une utilisation à intérieur afin de réduire les risques de brouillage préjudiciable aux systèmes de satellites mobiles utilisant les mêmes canaux;*
- (ii) le gain maximal d'antenne permis pour les dispositifs utilisant les bandes 5150-5250 MHz et 5470-5725 MHz doit se conformer à la limite de p.i.r.e.;*
- (iii) le gain maximal d'antenne permis (pour les dispositifs utilisant la bande 5725-5825 MHz) doit se conformer à la limite de p.i.r.e. spécifiée pour l'exploitation point à point et non point à point, selon le cas.*
- (iv) De plus, les utilisateurs devraient aussi être avisés que les utilisateurs de radars de haute puissance sont désignés utilisateurs principaux (c.-à-d ., qu'ils ont la priorité) pour les bandes 5250-5350 MHz et 5650-5850 MHz et que ces radars pourraient causer du brouillage et/ou des dommages aux dispositifs LAN-EL.mêmes canaux;*
- (II) le gain maximal d'antenne permis pour les dispositifs utilisant les bandes 5150-5250 MHz et 5470-5725 MHz doit se conformer à la limite de p.i.r.e.;*
- (III) le gain maximal d'antenne permis (pour les dispositifs utilisant la bande 5725-5825 MHz) doit se conformer à la limite de p.i.r.e. spécifiée pour l'exploitation point à point et non point à point, selon le cas.*
- (IV) De plus, les utilisateurs devraient aussi être avisés que les utilisateurs de radars de haute puissance sont désignés utilisateurs principaux (c.-à-d ., qu'ils ont la priorité) pour les bandes 5250-5350 MHz et 5650-5850 MHz et que ces radars pourraient causer du brouillage et/ou des dommages aux dispositifs LAN-EL.*

Appendix B: MediCapture Limited Warranty

MediCapture Inc. (“MediCapture”) warrants the product(s) listed below to be free of defects in materials and workmanship for a period of one (1) year. Should warranty service be required, the warranty period will be extended by the number of days required to restore normal operation and return the product(s).

MediCapture MVR / MVR Pro medical image recording device

Warranty Conditions

If, during the year that immediately follows the purchase date, a product covered by this warranty is found to have a defect in material or workmanship, MediCapture (or a service facility authorized by MediCapture) will restore the product to its original operating condition without charge for parts or labor. Note: MediCapture reserves the right to utilize reconditioned subassemblies as warranty replacements.

This warranty applies only to those products sold by retailers authorized by MediCapture to sell such products and is enforceable by the original purchaser only.

THIS WARRANTY IS APPLICABLE IN THE FIFTY (50) STATES OF THE USA AND THE DISTRICT OF COLUMBIA ONLY. IT IS NOT APPLICABLE IN THE POSSESSIONS OR TERRITORIES OF THE USA OR IN ANY OTHER COUNTRY. THIS IS THE ONLY EXPRESS WARRANTY WHICH MEDICAPTURE MAKES IN CONNECTION WITH THE ABOVE LISTED PRODUCT(S). ANY IMPLIED WARRANTIES APPLICABLE TO THESE PRODUCTS ARE LIMITED TO THE DURATION OF THE EXPRESS WARRANTY. MEDICAPTURE SHALL NOT BE LIABLE FOR LOSS OF REVENUES OR PROFITS, INCONVENIENCE, EXPENSE FOR SUBSTITUTE EQUIPMENT OR SERVICE, STORAGE CHARGES, LOSS OR CORRUPTION OF DATA, OR ANY OTHER SPECIAL, INCIDENTAL, OR CONSEQUENTIAL DAMAGES CAUSED BY THE USE OR MISUSE OF, OR INABILITY TO USE, THE ABOVE LISTED PRODUCT(S), REGARDLESS OF THE LEGAL THEORY ON WHICH THE CLAIM IS BASED, AND EVEN IF MEDICAPTURE HAS BEEN ADVISED OF THE POSSIBILITY OF SUCH DAMAGES. IN NO EVENT SHALL THE RECOVERY OF ANY KIND AGAINST MEDICAPTURE BE GREATER IN AMOUNT THAN THE PURCHASE PRICE OF THE PRODUCT(S) LISTED ABOVE AND CAUSING THE ALLEGED DAMAGE. WITHOUT LIMITING THE FOREGOING, YOU ASSUME ALL RISK AND LIABILITY FOR LOSS, DAMAGE OR INJURY TO YOU AND YOUR PROPERTY AND TO OTHERS AND THEIR PROPERTY ARISING OUT OF USE OR MISUSE, OR INABILITY TO USE, THE ABOVE LISTED PRODUCT(S) NOT CAUSED DIRECTLY BY THE NEGLIGENCE OF MEDICAPTURE (some STATES DO NOT ALLOW LIMITATIONS ON HOW LONG AN IMPLIED WARRANTY MAY LAST, OR DO NOT ALLOW THE EXCLUSION OR LIMITATION OF INCIDENTAL OR CONSEQUENTIAL DAMAGES, SO THE ABOVE EXCLUSION OR LIMITATION MAY NOT APPLY TO YOU).

This warranty gives you specific legal rights. You may also have other rights which vary from state to state. In the event any of the provisions of this warranty are found to be unenforceable, all remaining provisions shall retain full force.

Owner Responsibilities

- Read the Instructions for Use completely.
- Warranty registration is not necessary. However, should warranty service be required, you must be able to provide proof of the purchase date and the identity of the seller who made the sale (either MediCapture or an authorized reseller). Please save your sales receipt and invoice.
- Make sure that the proof of purchase that you save contains the serial number and that it matches the number on the unit that you purchased.
- Depending on where you purchased your unit, promptly notify either MediCapture or the authorized reseller of any malfunction upon discovery.
- In the event service is required, return the product to an authorized MediCapture service center. All shipments must be PREPAID. No COLLECT shipments will be accepted. Products repaired under warranty by MediCapture, or an authorized service center, will be returned to the sender PREPAID.
- Products returned for service (in or out of warranty) MUST have a Return Merchandise Authorization (RMA) number issued by MediCapture or an authorized service center.

Exclusions

IMPORTANT: The following conditions can cause this warranty to be unenforceable.

- Purchase of the product listed above from resellers NOT authorized by MediCapture to sell the product.
- Alteration or removal of the trademark, name, or identification number or serial number of the products.
- Use of parts or supplies (other than those sold by MediCapture) that cause damage to the products.
- Product failures that are the result of: neglect, abuse, misuse, modification, or accidental damage.